



河南省工程建设标准设计

DBJT19-07-2012

# 12系列建筑标准设计图集

河南省工程建设标准设计管理办公室 主编

12YJ4-1

常用门窗

中国建材工业出版社

张晓洁  
核  
审  
刘鹰  
对  
校  
王玉珏  
计  
设  
王玉珏  
图  
制

# 常用门窗

编制单位：内蒙古建校建筑勘察设计有限公司

编制单位负责人  
编制单位技术负责人  
技术审定人  
设计负责人

## 目 录

目录	01~03	平开窗立面图(一)~(四)	12~15
编制说明(一)~(五)	04~08	内平开下悬窗立面图	16
典型玻璃系统的光学热工参数	09	上悬窗立面图	17
常用整窗传热系数(K)计算表	010	内开叠合窗立面图(一)~(二)	18~19
铝塑、铝木、玻璃钢节能门窗性能表	011	固定窗立面图	20
典型窗的传热系数近似计算表	012	推拉窗立面图	21
平开半玻门立面图(一)~(二)	1~2	异型窗立面图	22
平开全玻门立面图(一)~(二)	3~4	平开组合窗立面图(一)~(二)	23~24
推拉半玻门立面图	5	推拉组合窗立面图(一)~(二)	25~26
推拉全玻门立面图	6	A型-铝合金门窗说明(一)~(三)	27~29
地弹簧门立面图(一)~(二)	7~8	A型-铝合金外平开门节点图	30
平开门连窗立面图(一)~(二)	9~10		
平开门连推拉窗立面图	11		

目 录(一)	图集号	12YJ4-1
	页次	01

张晚洁	张晚洁
核	
审	
刘鹰岚	刘鹰岚
对	
校	
王玉珏	王玉珏
计	
设	
王玉珏	王玉珏
图	
制	

A型—铝合金平开单玻门节点图	31	D型—塑料外平开门节点图(带门芯板)	58
A型—铝合金推拉单玻门节点图(一)~(二)	32~33	D型—塑料推拉门节点图	59
A型—铝合金平开组合中空玻璃窗拼接安装节点图(一)~(二)	34~35	D型—塑料地弹簧门节点图	60
A型—铝合金单玻门连窗节点图	36	D型—塑料外平开窗节点图	61
A型—铝合金地弹簧门基本门节点图(一)~(二)	37~38	D型—塑料内平开下悬窗节点图	62
铝合金地弹簧门安装节点图	39	D型—塑料推拉窗节点图	63
A型—铝合金内平开下悬窗节点图(一)~(三)	40~42	D型—塑料组合门窗拼装节点图	64
A型—铝合金外平开窗节点图	43	塑料窗框沿墙体中部安装节点图	65
A型—铝合金内平开三玻窗节点图	44	塑料窗框沿墙体外侧安装节点图	66
A型—铝合金推拉窗节点图(一)~(二)	45~46	塑料门窗通用安装节点图	67
铝合金门窗安装节点图	47	组合窗拼接安装节点图	68
外门窗有附框安装节点图	48	E型—玻璃钢节能门窗说明(一)~(二)	69~70
B型、C型—铝塑复合、木包铝节能门窗说明	49	E型—玻璃钢推拉门节点图	71
B型—内平开下悬铝塑复合窗节点图	50	E型—玻璃钢阳台门连窗节点图(无槛)	72
B型—外平开铝塑复合窗节点图	51	E型—玻璃钢内平开窗节点图	73
C型—木包铝外平开门节点图	52	F型—木门窗说明(一)~(三)	74~76
C型—木包铝平开下悬窗节点图	53	木门类型尺寸	77
D型—塑料门窗说明(一)~(三)	54~56	平开夹板门立面图	78
D型—塑料内平开门节点图	57	平开夹板百叶门立面图	79

## 目 录(二)

图集号	12YJ4-1
页次	02

张 晓 洁	张 晓 洁
核 审	
刘 鹰 凤	刘 鹰 凤
对 校	
王 玉 珏	王 玉 珏
计 设	
王 玉 珏	王 玉 珏
图 制	

平开半玻夹板门立面图	80	F型-推拉窗节点图(一)~(二)	111~112
平开条形玻璃门立面图	81	门窗套部件截面图(一)~(二)	113~114
平开实木花格镶整玻璃门立面图	82	平开门安装节点图	115
平开镶板门立面图	83	平开门连窗安装节点图	116
平开半玻镶板门立面图	84		
平开全玻门立面图	85		
模压门立面图(一)~(二)	86~87		
平开门连窗立面图	88		
平开门连推拉窗立面图	89		
弹簧镶玻璃门(半截玻璃)立面图(一)~(二)	90~91		
弹簧镶玻璃门立面图(三玻一板)(一)~(二)	92~93		
平开窗立面图	94		
推拉窗立面图(一)~(二)	95~96		
F型-夹板门节点图	97		
F型-镶板门节点图	98		
F型-平开门节点图(一)~(四)	99~102		
F型-平开门连窗节点图	103		
F型-平开门连推拉窗节点图(一)~(三)	104~106		
F型-单玻内平开窗节点图(一)~(二)	107~108		
F型-室内平开窗节点图(一)~(二)	109~110		

### 目 录(三)

图集号	12YJ4-1
页次	03

张  
晓  
洁

核  
审

侯  
红  
霞

对  
校

刘  
鹰  
凤

计  
设

曹  
越

图  
制

## 编 制 说 明

### 1. 适用范围

本图集适用于民用建筑和一般工业建筑的普通门窗。

### 2. 编制依据

《建筑门窗术语》 ..... (GB/T 5823-2008)

《建筑门窗洞口尺寸系列》 ..... (GB/T 5824-2008)

《民用建筑热工设计规范》 ..... (GB 50176-93)

《公共建筑节能设计标准》 ..... (GB 50189-2005)

《建筑门窗玻璃幕墙热工计算规程》 ..... (JGJ/T 151-2008)

《夏热冬冷地区居住建筑节能设计标准》 ..... (JGJ 134-2010)

《严寒和寒冷地区居住建筑节能设计标准》 ..... (JGJ 26-2010)

《建筑外门窗保温性能分级及检测方法》 ..... (GB/T 8484-2008)

《建筑外门窗气密、水密、抗风压性能分级及检测方法》

..... (GB/T 7106-2008)

《建筑外窗采光性能分级及检测方法》 ..... (GB/T 11976-2002)

《建筑外门窗空气声隔声性能分级及检测方法》 ..... (GB/T 8485-2008)

《建筑采光设计标准》 ..... (GB 50033-2013)

《民用建筑隔声设计规范》 ..... (GB 50118-2010)

《建筑门窗、幕墙用密封胶条》 ..... (GB/T 24498-2009)

《建筑玻璃应用技术规程》 ..... (JGJ 113-2009)

《建筑装饰装修工程质量验收规范》 ..... (GB 50210-2001)

《建筑节能工程施工质量验收规范》 ..... (GB 50411-2007)

《民用建筑工程室内环境污染控制规范》 ..... (GB 50325-2010)

国家、行业现行有关规范及标准

图集使用中,本图集所依据的标准、规范若有新的版本时,选用者应按有效版本对图集的有关做法进行检查、核对、调整,以使所选做法符合相关规范有效版本的要求。

### 3. 编制内容

3.1 内容以铝合金、塑料、木制等材质的常用门窗为主,包括玻璃钢、铝塑、铝木复合型节能门窗。

3.2 说明、门窗立面示意图。

3.3 平开门、推拉门、弹簧门、平开窗、推拉窗、内平开下悬窗等基本门窗构造节点示意图。

3.4 基本门窗安装节点图、组合窗拼接安装节点图。

### 4. 设计规定

4.1 本图集的立面图均为由外向内所得立面,细实线表示向外开启,细虚线表示向内开启。推拉门窗以箭头表示推拉方向。

4.2 因为铝合金门窗和塑料门窗以及玻璃钢、铝塑、铝木节能门窗的立面形式比较接近,为方便选用,绘制了共同的立面选用图。木门窗立面选用图单独表达。

4.3 本图集未注明单位的尺寸均以毫米为单位。

4.4 本图集所列门窗为基本窗型,设计选用过程中,应根据工程所

编制说明(一)

图集号

12YJ4-1

页次

04

张晚洁  
核  
侯红霞  
对  
刘鹏飞  
校  
计  
曹越  
设  
曹越  
图  
制

在地区进行设计核算主受力杆件的强度，选用的五金件及其紧固件也应与核算结果相适应。

4.5 门窗类型代号见表4.5。

表 4.5 门窗类型代号

名称	代号	名称	代号
平开门	PM	内开叠合窗	DPC
推拉门	TM	上悬窗	SXC
平开门连窗	LCM	固定窗	GC
平开门连推拉窗	TLCM	推拉窗	TC
弹簧门	HM	异形窗	YC
平开窗	PC	平开组合窗	ZPC
内平开下悬窗	PXC	推拉组合窗	ZTC

4.6 门窗编号:

门窗材质: 塑料 S 铝合金 L 木 M 玻璃钢 BG  
 铝塑 LS 铝木 LM 单玻 D 中空玻璃 K  
 带纱扇 F 料型: 60、70、80

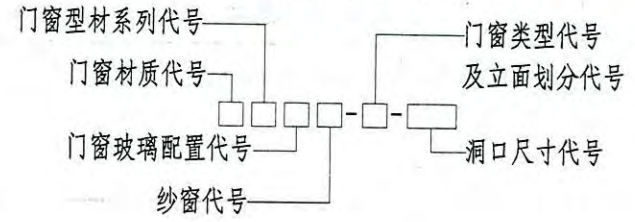

如: S70KF-PC1-1518 为塑料70系列中空玻璃带纱、上亮子平开窗, 洞口宽1500, 洞口高1800。在门窗选用表和施工图平面中标注门、窗编号时可省略前面的特征代号, 统一在工程设计说明中注明。门窗选用表和工程图中门窗编号只写类型代号和洞口宽、高代号。

如: PC1-1518。(若同时多种材质的窗立面与洞口一致时会产生同号, 请设计人在工程图中门窗备注中分别说明。)

4.7 节点详图索引方法:

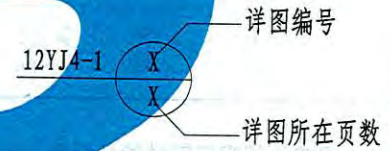

4.8 门窗节点图方位:

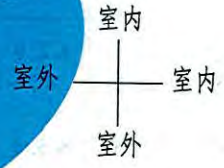

5. 技术要求

5.1 门窗的物理性能指标要求

门窗的抗风压、水密、气密、保温、抗结露因子分级、隔声、遮阳、采光等八大性能分级指标见表5-1~表5-8。

编制说明 (二)	图集号	12YJ4-1
	页次	05

张 晓 洁  
核 审  
侯 红 霞  
对 校  
刘 鹰 岚  
计 设  
曹 越 曹 越  
图 制

表 5-1 建筑外门窗抗风压性能分级表 (GB/T 7106-2008)

分级代号	2	3	4	5	6	7	8	9
$P_3$ (kPa)	$\geq 1.5$ $< 2.0$	$\geq 2.0$ $< 2.5$	$\geq 2.5$ $< 3.0$	$\geq 3.0$ $< 3.5$	$\geq 3.5$ $< 4.0$	$\geq 4.0$ $< 4.5$	$\geq 4.5$ $< 5.0$	$\geq 5.0$

表 5-2 建筑外门窗水密性能分级表 (GB/T 7106-2008)

分级代号	2	3	4	5	6
$\Delta P$ (Pa)	$\geq 150$ $< 250$	$\geq 250$ $< 350$	$\geq 350$ $< 500$	$\geq 500$ $< 700$	$\geq 700$

表 5-3 建筑外门窗气密性能分级表 (GB/T 7106-2008)

分级代号	3	4	5	6	7	8
$q_1$ [ $m^3/(m \cdot h)$ ]	$\leq 3.0$ $> 2.5$	$\leq 2.5$ $> 2.0$	$\leq 2.0$ $> 1.5$	$\leq 1.5$ $> 1.0$	$\leq 1.0$ $> 0.5$	$\leq 0.5$
$q_2$ [ $m^3/(m^2 \cdot h)$ ]	$\leq 9.0$ $> 7.5$	$\leq 7.5$ $> 6.0$	$\leq 6.0$ $> 4.5$	$\leq 4.5$ $> 3.0$	$\leq 3.0$ $> 1.5$	$\leq 1.5$

表 5-4 建筑外门窗保温性能分级表 (GB/T 8484-2008)

分级代号	3	4	5	6	7	8	9	10
$K$ [ $W/(m^2 \cdot K)$ ]	$\geq 3.5$ $< 4.0$	$\geq 3.0$ $< 3.5$	$\geq 2.5$ $< 3.0$	$\geq 2.0$ $< 2.5$	$\geq 1.6$ $< 2.0$	$\geq 1.3$ $< 1.6$	$\geq 1.1$ $< 1.3$	$< 1.1$

表 5-5 玻璃门、外窗抗结露因子分级 (GB/T 8484-2008)

分级代号	3	4	5	6	7	8	9	10
CRF	$> 40$ $\leq 45$	$> 45$ $\leq 50$	$> 50$ $\leq 55$	$> 55$ $\leq 60$	$> 60$ $\leq 65$	$> 65$ $\leq 70$	$> 70$ $\leq 75$	$> 75$

表 5-6 建筑门窗空气隔声性能分级表 (GB/T 8485-2008)

分级代号	2	3	4	5	6
外门、外窗 $R_w + C_{tr}$ (dB)	$\geq 25$ $< 30$	$\geq 30$ $< 35$	$\geq 35$ $< 40$	$\geq 40$ $< 45$	$\geq 45$
内门、内窗 $R_w + C$ (dB)	$\geq 25$ $< 30$	$\geq 30$ $< 35$	$\geq 35$ $< 40$	$\geq 40$ $< 45$	$\geq 45$

注：用于建筑内机器、设备噪声源隔声的建筑内门窗，对中低频噪声宜用外门窗的指标值进行分级；对中高频噪声仍可采用内门窗的指标值进行分级。

表 5-7 建筑外窗采光性能分级表 (GB/T 11976-2002)

分级代号	1	2	3	4	5
采光性能 $T_r$	$\geq 0.20$ $< 0.30$	$\geq 0.30$ $< 0.40$	$\geq 0.40$ $< 0.50$	$\geq 0.50$ $< 0.60$	$\geq 0.60$

注： $T_r$ (透射光折减系数)值  $> 0.60$ 时，应给出具体数值

张院洁
核
审
侯红霞
对
校
刘鹏飞
计
设
曹越
图
制

表5-8 建筑外窗玻璃遮阳性能分级表 (JG/T 274-2010)

分级代号	1	2	3	4	5	6
分级指标 SC	>0.7	>0.6 ≤0.7	>0.5 ≤0.6	>0.4 ≤0.5	>0.3 ≤0.4	≤0.3

5.2 设计选用说明:

5.2.1 门窗抗风压性能,门窗的强度应能满足所在地区的最大正、负风压作用时的要求。尤其是风力较大的地区(如沿海地区等)及高层建筑、高层建筑或位于大风压的建筑设计应提出窗的具体强度指标或其抗风压性能等级。

5.2.2 门窗的气密性,外门窗及敞开式阳台门应具有良好的密闭性能。居住建筑严寒地区外窗及敞开式阳台门的气密性等级不应低于国家标准规定的6级;寒冷地区、夏热冬冷地区1~6层的外窗及敞开式阳台门的气密性等级不应低于国家标准中规定的4级,7层及7层以上不应低于6级。公共建筑外窗的气密性等级不应低于国家标准规定的4级。

5.2.3 门窗的水密性,在位于大风压且多雨地区时,门窗的水密性不应低于3级。

5.2.4 门窗的隔声性,沿街住宅或当环境噪声较大时,应采用隔声性能较好的外窗。可采用中空玻璃或双层窗,以提高其隔声性能。

5.2.5 窗的保温性能等级应按建筑所在地现行的建筑节能设计标准的规定确定。

5.3 每类门窗均有高、中、低不同档次,其区分主要表现在型材及五金配件的档次,组装加工的精密程度,物理性能的等级,型材表面的

处理等。

5.4 门窗立面设计

5.4.1 立面尺寸应根据天然采光设计要求的各类用房窗地面积比和建筑节能要求的窗墙面积比等综合因素合理确定。

5.4.2 立面分格尺寸应根据玻璃抗风压设计计算最大许用面积、开启扇允许最大高、宽尺寸,并考虑玻璃原片的成材率等综合确定。平开窗的开启扇,其净宽不宜大于0.6m,净高不宜大于1.4m。推拉窗的开启扇,其净宽不宜大于0.9m,净高不宜大于1.5m。如超出,需另行复核验算,以保证窗扇及五金配件的强度、玻璃的荷载满足建筑物的物理性能要求及其力学性能要求。

5.4.3 立面开启形式和开启面积比例,应根据各类用房的使用特点,满足房间自然通风的要求,保证启闭、清洁、维修的方便性和安全性。居住建筑外窗可开启面积(含阳台门面积)不应小于外窗所在房间地面面积的5%,公共建筑外窗的可开启面积不应小于窗面积的30%。

5.5 门窗的安全设计

5.5.1 开启门扇和固定门以及落地窗玻璃的设计选用,必须符合现行行业标准《建筑玻璃应用技术规程》JGJ113中的人体冲击安全规定。

5.5.2 门窗工程有下列情况之一时,必须使用安全玻璃:

1. 面积大于1.5m<sup>2</sup>的窗玻璃或玻璃底边离最终装修面小于500mm的落地窗;
2. 7层及7层以上建筑物外开窗;
3. 倾斜装配窗、天窗;

编制说明(四)

图集号	12YJ4-1
页次	07



张 晓 浩  
核 审  
侯 红 霞  
对 校  
刘 腾 凤  
计 设  
曹 越 曹 越  
图 制

4. 双面弹簧门应在可视高度部分装透明安全玻璃。  
5. 公共建筑物的出入口、门厅等部位。门玻璃应在视线高度设置明显的警示标志。

5.5.3 高层建筑应采用内开式窗，7层及7层以上不允许采用外平开窗。

5.5.4 推拉门、推拉窗的扇应有防止从室外侧拆卸的装置。推拉窗用于外墙时应设置防止窗扇向室外脱落的装置

5.6 门窗应采用预留洞口法安装，不能直接与水泥砂浆接触，应按相关规范、规程的规定施工。有外保温或外饰面材料较厚时，外窗宜采用增加钢附框的安装方式。门窗与洞口的连接应牢固可靠。连接固定方式，宜采用干法施工。

门窗的构造尺寸应考虑预留洞口与待安装门、窗框的间隙及墙体饰面材料的厚度。洞口与门窗框间隙应符合表 5.6 的规定。

表 5.6 洞口与门、窗框间隙

墙体外饰面材料	洞口与门窗框缝隙(mm)
清水墙及附框	10
水泥砂浆或贴陶瓷锦砖	15~20
贴釉面瓷砖	20~25
贴大理石或花岗石板	40~50
外保温墙体	保温层厚度+10

注：1 本表摘自《塑料门窗工程技术规程》JGJ103-2008；

2. 当饰面为石材时，缝隙宽尚应酌情增加，以饰面层厚度能盖过缝隙5~10mm之间为度，但又不宜压盖框料过多；当外墙有外保温时，应按保温层厚度留出缝或设钢附框。

5.7 一般民用建筑的外窗均应考虑擦窗问题。如采用大固定小开启的窗，其固定玻璃部分的面积不宜过大，应考虑有从室内擦净玻璃的可能。当为外开窗时，靠洞口两侧的外开扇或单扇的外平窗，宜选用滑撑五金件，以利擦窗。

5.8 外门窗的保温与隔热性能设计

5.8.1 保温性能(传热系数K)：K越低，玻璃阻隔热量传递的性能越好，因此尽量选择K值较低的玻璃。应采用中空玻璃、低辐射镀膜玻璃、真空玻璃；中空玻璃气体间层的厚度不宜小于9mm，严寒地区宜采用中空Low-E镀膜玻璃或单框三玻中空玻璃，不宜使用推拉窗。

5.8.2 典型玻璃系统的光学热工参数见09页附表1。

5.8.3 不同地区的建筑应根据当地气候特点选择不同遮阳系数(SC)的玻璃，在满足遮阳系数条件下，宜选择高透光率的玻璃品种。当外窗的遮阳系数(SC)不能满足国家或地方建筑节能标准的要求时应加设外遮阳措施，以满足要求。

5.8.4 玻璃镶嵌密封和框扇之间的密封应采用耐久性好并具有良好弹性的密封胶或密封胶条；

5.8.5 门窗框与洞口墙体之间的安装缝隙进行保温处理。

5.8.6 外窗整窗热工性能详见010~011页附表2~附表3。

编制说明(五)

图集号	12YJ4-1
页次	08

张 晓 洁  
张 晓 洁

核 审

侯 红 霞  
侯 红 霞

对 校

刘 鹰 凤  
刘 鹰 凤

计 设

曹 越  
曹 越

图 制

附表 1

典型玻璃系统的光学热工参数

玻璃品种 (mm)	可见光透射比	太阳光总透射比	遮阳系数	传热系数	
	$\tau_v$	$g_g$	SC	U(K) [W/(m <sup>2</sup> ·K)]	
透明玻璃	3透明玻璃	0.83	0.87	1.00	5.8
	6透明玻璃	0.77	0.82	0.93	5.7
	12透明玻璃	0.65	0.74	0.84	5.5
吸热玻璃	5绿色吸热玻璃	0.77	0.64	0.76	5.7
	6蓝色吸热玻璃	0.54	0.62	0.72	5.7
	5茶色吸热玻璃	0.50	0.62	0.72	5.7
	5灰色吸热玻璃	0.42	0.60	0.69	5.7
	6高透光热反射玻璃	0.56	0.56	0.64	5.7
热反射玻璃	6中等透光热反射玻璃	0.40	0.43	0.49	5.4
	6低透光热反射玻璃	0.15	0.26	0.30	4.6
	6特低透光热反射玻璃	0.11	0.25	0.29	4.6
	6高透光Low-E玻璃	0.61	0.51	0.58	3.6
单片Low-E玻璃	6中等透光型Low-E玻璃	0.55	0.44	0.51	3.5
	6透明+12空气+6透明	0.71	0.75	0.86	2.8
中空玻璃	6绿色吸热+12空气+6透明	0.66	0.47	0.54	2.8
	6灰色吸热+12空气+6透明	0.38	0.45	0.51	2.8
	6中等透光热反射+12空气+6透明	0.28	0.29	0.34	2.4
	6低透光热反射+12空气+6透明	0.16	0.16	0.18	2.3
	6高透光Low-E+12空气+6透明	0.72	0.47	0.62	1.9
	6中透光Low-E+12空气+6透明	0.62	0.37	0.50	1.8
	6较低透光Low-E+12空气+6透明	0.48	0.28	0.38	1.8
	6低透光Low-E+12空气+6透明	0.35	0.20	0.30	1.8
	6高透光Low-E+12氩气+6透明	0.72	0.47	0.62	1.5
	6中透光Low-E+12氩气+6透明	0.62	0.37	0.50	1.4

注：本页数据引自《建筑门窗玻璃幕墙热工计算规程》 JGJ/T 151-2008。

典型玻璃系统的 optical 热工参数

图集号	12YJ4-1
页次	09

张晚洁

核  
审

侯红霞

对  
校

刘鹰岚

计  
设

曹越

制  
图

附表 2

常用整窗传热系数(K)计算表

玻 璃				普通铝窗框			断桥铝窗框		木窗框		塑料窗框	
				K=6.66 W/(m <sup>2</sup> ·h)			K=4.0 W/(m <sup>2</sup> ·h)		K=1.8 W/(m <sup>2</sup> ·h)		K=1.9 W/(m <sup>2</sup> ·h)	
种 类	结 构	遮阳系数 SC	K 值 W/(m <sup>2</sup> ·h)	窗框窗洞面积比			窗框窗洞面积比		窗框窗洞面积比		窗框窗洞面积比	
				15%	20%	30%	20%	30%	30%	35%	30%	35%
单 片	5mm 白玻	0.99	5.5	5.7	5.7	5.8	5.2	5.1	4.4	4.2	4.4	4.2
	5mm 绿玻	0.70	5.5	5.7	5.7	5.8	5.2	5.1	4.4	4.2	4.4	4.2
白玻中空	5mm+6A+5mm	0.89	3.2	3.7	3.9	4.2	3.4	3.4	2.8	2.7	2.8	2.7
	5mm+9A+5mm	0.89	3.0	3.5	3.7	4.1	3.2	3.3	2.6	2.6	2.7	2.6
	5mm+12A+5mm	0.89	2.8	3.4	3.6	4.0	3.0	3.2	2.5	2.5	2.5	2.5
	6mm+6A+6mm	0.87	3.2	3.7	3.9	4.2	3.4	3.4	2.8	2.7	2.8	2.7
	6mm+9A+6mm	0.87	2.9	3.5	3.7	4.0	3.1	3.2	2.6	2.5	2.6	2.6
	6mm+12A+6mm	0.87	2.8	3.4	3.6	4.0	3.0	3.2	2.5	2.5	2.5	2.5
Low-E中空 SuperSE-I	5mm+6A+5mm	0.60	2.5	3.1	3.3	3.7	2.8	3.0	2.3	2.3	2.3	2.3
	5mm+9A+5mm	0.60	2.0	2.7	2.9	3.4	2.4	2.6	1.9	1.9	2.0	2.0
	5mm+12A+5mm	0.60	1.9	2.6	2.9	3.3	2.3	2.5	1.9	1.9	1.9	1.9
	6mm+6A+6mm	0.60	2.5	3.1	3.3	3.7	2.8	3.0	2.3	2.3	2.3	2.3
	6mm+9A+6mm	0.60	2.0	2.7	2.9	3.4	2.4	2.6	1.9	1.9	2.0	2.0
	6mm+12A+6mm	0.59	1.8	2.5	2.8	3.3	2.2	2.5	1.8	1.8	1.8	1.8
Low-E中空 SuperSE-III	5mm+6A+5mm	0.50	2.5	3.1	3.3	3.7	2.8	3.0	2.3	2.3	2.3	2.3
	5mm+9A+5mm	0.49	2.0	2.7	2.9	3.4	2.4	2.6	1.9	1.9	2.0	2.0
	5mm+12A+5mm	0.49	1.9	2.6	2.9	3.3	2.3	2.5	1.9	1.9	1.9	1.9
	6mm+6A+6mm	0.49	2.5	3.1	3.3	3.7	2.8	3.0	2.3	2.3	2.3	2.3
	6mm+9A+6mm	0.48	2.0	2.7	2.9	3.4	2.4	2.6	1.9	1.9	2.0	2.0
	6mm+12A+6mm	0.48	1.8	2.5	2.8	3.3	2.2	2.5	1.8	1.8	1.8	1.8

注：表中数据仅供设计时参考，具体工程应以厂家提供国家认可检测机构的检测报告中数据为准。

常用整窗传热系数(K)计算表

图集号

12YJ4-1

页次

010

张晚洁  
张晚洁

核  
审

侯红霞  
侯红霞

对  
校

刘鹰岚  
刘鹰岚

计  
设

曹越  
曹越

图  
制

附表 3

铝塑、铝木、玻璃钢节能门窗性能表

项目 门窗型号		玻璃配置 (白玻)	抗风压性能P (kPa)	水密性能 $\Delta P$ (Pa)	气密性能		保温性能K [W/(m <sup>2</sup> ·K)]	隔声性能 (dB)	
					$q_1$ [m <sup>3</sup> /(m <sup>2</sup> ·h)]	$q_2$ [m <sup>3</sup> /(m <sup>2</sup> ·h)]			
B型	铝塑节能门窗	60系列平开窗	5+9A+5	≥4.5	≥350	≤1.5	≤4.5	2.7-2.9	≥30
			5+12A+5	≥4.5	≥350	≤1.5	≤4.5	2.3-2.6	≥32
			5+12A+5Low-E	≥4.5	≥350	≤1.5	≤4.5	1.8-2.0	≥32
			5+12A+5+12A+5	≥4.5	≥350	≤1.5	≤4.5	1.6-1.9	≥35
			5+12A+5+12A+5Low-E	≥4.5	≥350	≤1.5	≤4.5	1.2-1.5	≥35
C型	木包铝节能门窗	60系列平开窗	5+12A+5	3.5	≥500	≤0.5	—	2.7	32
E型	玻璃钢节能门窗	50系列平开窗	4+9A+5	3.5	250	0.10	0.3	2.2	35
		58系列平开窗	5+12A+5Low-E	5.3	250	0.46	1.20	2.2	36
		58系列平开窗	5+9A+4+6A+5	5.3	250	0.46	1.20	1.8	39
		58系列平开窗	5Low-E+12A+4+9A+5	5.3	250	0.46	1.20	1.3	39
		58系列平开窗	4+V(真空)+4+9A+5	5.3	250	0.46	1.20	1.0	36

注：表中数据仅供设计时参考，具体工程应以厂家提供国家认可检测机构的检测报告中数据为准。

铝塑、铝木、玻璃钢  
节能门窗性能表

图集号  
页

12YJ4-1  
011

张皓  
核  
审  
侯红霞  
对  
校  
刘鹰岚  
设计  
曹越  
曹越  
制图

附表 4 窗框面积占整樘窗面积30%的窗户传热系数

玻璃传热系数 U(K) [W/(m <sup>2</sup> ·K)]	窗框传热系数 U(K)								
	1.0	1.4	1.8	2.2	2.6	3.0	3.4	3.8	7.0
5.7	4.3	4.4	4.5	4.6	4.8	4.9	5.0	5.1	6.1
3.3	2.7	2.8	2.9	3.1	3.2	3.4	3.5	3.6	4.4
3.1	2.6	2.7	2.8	2.9	3.1	3.2	3.3	3.5	4.3
2.9	2.4	2.5	2.7	2.8	3.0	3.1	3.2	3.3	4.1
2.7	2.3	2.4	2.5	2.6	2.8	2.9	3.1	3.2	4.0
2.5	2.2	2.3	2.4	2.6	2.7	2.8	3.0	3.1	3.9
2.3	2.1	2.2	2.3	2.4	2.6	2.7	2.8	2.9	3.8
2.1	1.9	2.0	2.2	2.3	2.4	2.6	2.7	2.8	3.6
1.9	1.8	1.9	2.0	2.1	2.3	2.4	2.5	2.7	3.5
1.7	1.6	1.8	1.9	2.0	2.2	2.3	2.4	2.5	3.3
1.5	1.5	1.6	1.7	1.9	2.0	2.1	2.3	2.4	3.2
1.3	1.4	1.5	1.6	1.7	1.9	2.0	2.1	2.2	3.1
1.1	1.2	1.3	1.5	1.6	1.7	1.9	2.0	2.1	2.9
0.9	1.1	1.2	1.3	1.4	1.6	1.7	1.8	2.0	2.8
0.7	0.9	1.1	1.2	1.3	1.5	1.6	1.7	1.8	2.6
0.5	0.8	0.9	1.0	1.2	1.3	1.4	1.6	1.7	2.5

附表 5 窗框面积占整樘窗面积20%的窗户传热系数

玻璃传热系数 U(K) [W/(m <sup>2</sup> ·K)]	窗框传热系数 U(K)								
	1.0	1.4	1.8	2.2	2.6	3.0	3.4	3.8	7.0
5.7	4.8	4.8	4.9	5.0	5.1	5.2	5.2	5.3	5.9
3.3	2.9	3.0	3.1	3.2	3.3	3.4	3.4	3.5	4.0
3.1	2.8	2.8	2.9	3.0	3.1	3.2	3.3	3.4	3.9
2.9	2.6	2.7	2.8	2.8	3.0	3.0	3.1	3.2	3.7
2.7	2.4	2.5	2.6	2.7	2.8	2.9	3.0	3.0	3.6
2.5	2.3	2.4	2.5	2.6	2.7	2.7	2.8	2.9	3.4
2.3	2.1	2.2	2.3	2.4	2.5	2.6	2.7	2.7	3.3
2.1	2.0	2.1	2.2	2.2	2.3	2.4	2.5	2.6	3.1
1.9	1.8	1.9	2.0	2.1	2.2	2.3	2.3	2.4	3.0
1.7	1.7	1.8	1.8	1.9	2.0	2.1	2.2	2.3	2.8
1.5	1.5	1.6	1.7	1.8	1.9	1.9	2.0	2.1	2.6
1.3	1.4	1.4	1.5	1.6	1.7	1.8	1.9	2.0	2.5
1.1	1.2	1.3	1.4	1.4	1.5	1.6	1.7	1.8	2.3
0.9	1.0	1.1	1.2	1.3	1.4	1.5	1.6	1.6	2.2
0.7	0.9	1.0	1.0	1.1	1.2	1.3	1.4	1.5	2.0
0.5	0.7	0.8	0.9	1.0	1.1	1.2	1.2	1.3	1.8

注: 1. 在没有精确计算的情况下, 典型窗的传热系数可采用上表近似计算。

2. 本页数据摘自《建筑门窗玻璃幕墙热工计算规程》JGJ/T 151-2008。

典型窗的传热系数近似计算表











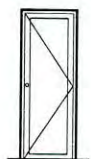
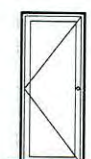

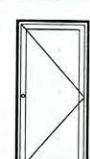

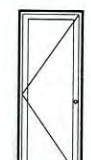

图集号	12YJ4-1
页次	012

制 图	郝晓丹	设计	郝晓丹	对 校	刘鹰岚	核 审	张 晓 洁	700	800	900	
								2100	PM1-0721 PM2-0721 PM3-0721 PM4-0721	PM1-0821 PM2-0821 PM3-0821 PM4-0821	PM1-0921 PM2-0921 PM3-0921 PM4-0921
								2400	PM1-0724 PM2-0724 PM3-0724 PM4-0724	PM1-0824 PM2-0824 PM3-0824 PM4-0824	PM1-0924 PM2-0924 PM3-0924 PM4-0924
2700	PM1-0727 PM2-0727 PM3-0727 PM4-0727	PM1-0827 PM2-0827 PM3-0827 PM4-0827	PM1-0927 PM2-0927 PM3-0927 PM4-0927								
注：1. 门扇宽度不宜大于1000，高度不宜大于2400。 2. 门芯板用于室外时，门芯板内应填充保温材料，满足节能要求。								平开半玻门立面图（一）		图集号 12YJ4-1	
										页次 1	

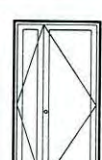
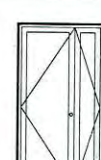
制 图		2400	1000				1200		1500	
			PM1-1024	PM2-1024	PM3-1024	PM4-1024	PM1-1224	PM2-1224	PM1-1524	PM2-1524
刘 凤 核 对	张 晓 洁 审 核	2100	PM1-1021	PM2-1021	PM3-1021	PM4-1021	PM1-1221	PM2-1221	PM1-1521	PM2-1521
			PM1-1023	PM2-1023	PM3-1023	PM4-1023	PM1-1223	PM2-1223	PM1-1523	PM2-1523
制 图	张 晓 洁 制 图	2700	PM1-1027	PM2-1027	PM3-1027	PM4-1027	PM1-1227	PM2-1227	PM1-1527	PM2-1527

注：1. 门扇宽度不宜大于1000，高度不宜大于2400。2. 门芯板用于室外时，门芯板内应填充保温材料，满足节能要求。3. 双扇开启的门洞宽度不应小于1200，当为1200时，易采用大小扇的形式。

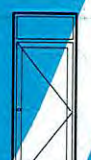

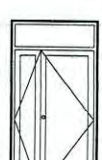
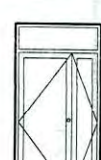
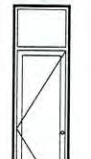
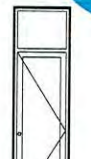
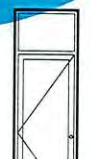
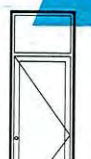
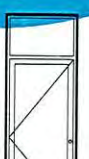
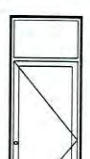
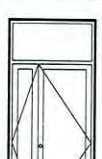
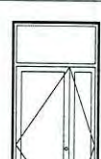



平开半玻门立面图（二）

制图 郝晓丹 设计 郝晓丹 校对 郝晓丹 审核 刘鹰岚 张晓洁	2100	800	 PM1-0821	 PM2-0821	900	 PM1-0921	 PM2-0921	1000	 PM1-1021	 PM2-1021	1200	 PM1-1221	 PM2-1221
	2300	800	 PM1-0823	 PM2-0823	900	 PM1-0923	 PM2-0923	1000	 PM1-1023	 PM2-1023	1200	 PM1-1223	 PM2-1223
	2400	800	 PM1-0824	 PM2-0824	900	 PM1-0924	 PM2-0924	1000	 PM1-1024	 PM2-1024	1200	 PM1-1224	 PM2-1224
	2700	800	 PM1-0827	 PM2-0827	900	 PM1-0927	 PM2-0927	1000	 PM1-1027	 PM2-1027	1200	 PM1-1227	 PM2-1227
	注：1. 门扇宽度不宜大于1000，高度不宜大于2400。 2. 双扇开启的门洞宽度不应小于1200，当为1200时，易采用大小扇的形式。												

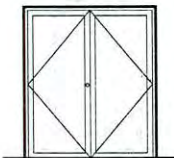
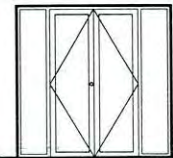
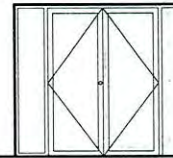
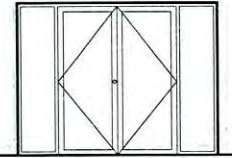
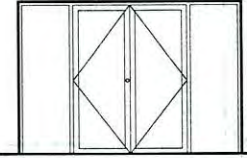
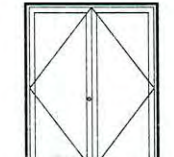

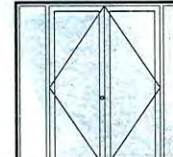
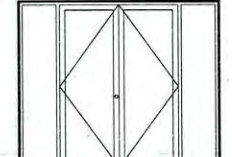
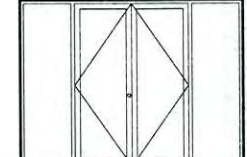
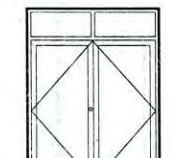
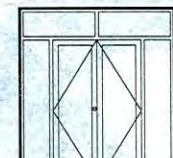

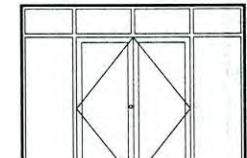
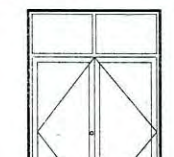
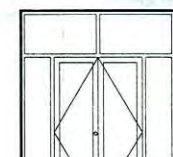
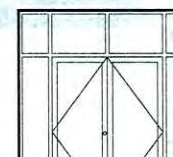
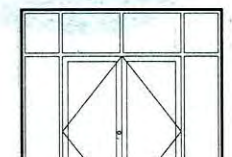







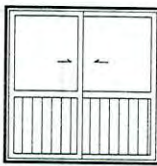

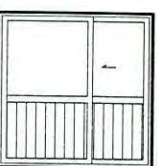
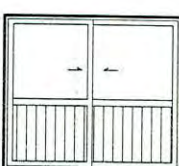



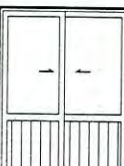



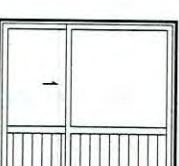





平开全玻门立面图（一）

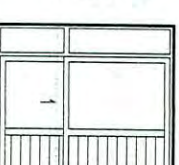

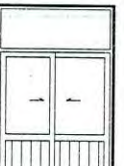



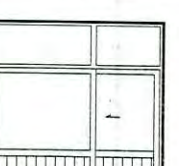

图集号	12YJ4-1
页次	3

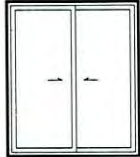
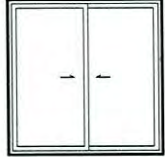
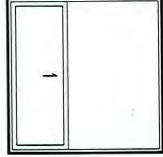
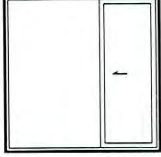
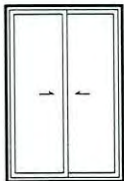
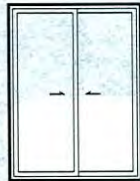

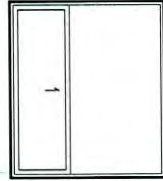
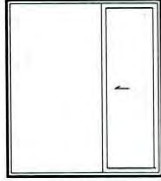
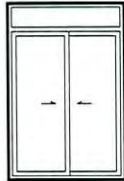
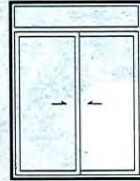

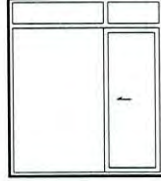

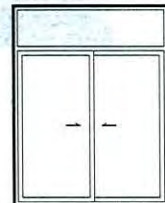

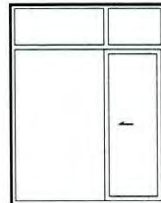

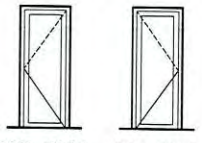
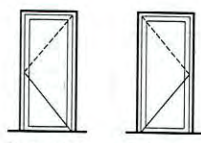
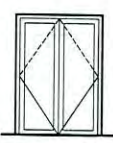
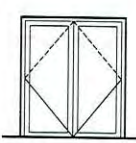
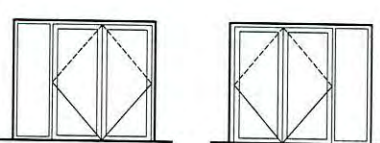
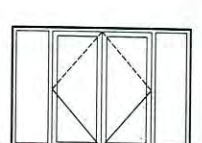
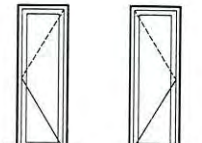
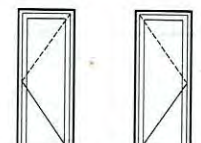

制图 郝晓丹 设计 郝晓丹 校对 郝晓丹 审核 刘鹰斌 张晚洁	2100	1800	2100	2400	2700	3000
	 PM-1821	 PM-2121	 PM-2421	 PM-2721	 PM-3021	
	2300	 PM-1823	 PM-2123	 PM-2423	 PM-2723	 PM-3023
	2400	 PM-1824	 PM-2124	 PM-2424	 PM-2724	 PM-3024
2700	 PM-1827	 PM-2127	 PM-2427	 PM-2727	 PM-3027	
注：1. 门扇宽度不宜大于1000，高度不宜大于2400。					图集号 12YJ4-1 页次 4	

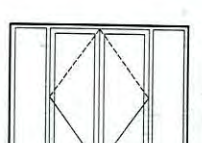
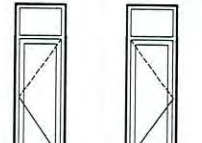
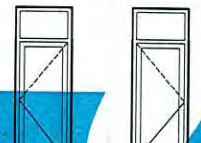
平开全玻门立面图（二）

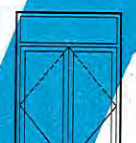
张 晓 洁 核 对 刘 鹰 凤 校 对 郝 晓 丹 设 计 郝 晓 丹 制 图	净宽	1500	1800	2100			2400		
	2100	 TM-1521	 TM-1821	 TM1-2121	 TM2-2121	 TM3-2121	 TM1-2421	 TM2-2421	 TM3-2421
	2400	 TM1-1524	 TM1-1824	 TM1-2124	 TM2-2124	 TM3-2124	 TM1-2424	 TM2-2424	 TM3-2424
		 TM2-1524	 TM2-1824	 TM4-2124	 TM5-2124	 TM6-2124	 TM4-2424	 TM5-2424	 TM6-2424
2700	 TM-1527	 TM-1827	 TM1-2127	 TM2-2127	 TM3-2127	 TM1-2427	 TM2-2427	 TM3-2427	
注：推拉门不应用于疏散门，且门扇净宽度不宜小于700，高度不宜大于2400。						推拉半玻门立面图			图集号 12YJ4-1
									页次 5

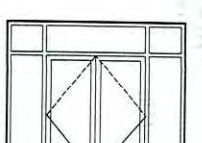
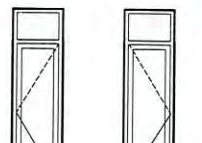
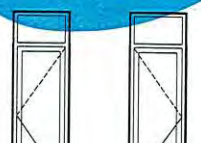
制 图	制 图 人 郝晓丹	设 计	校 对 人 郝晓丹	审 核 人 刘鹰岚	张 晓 洁	通高	1500	1800	2100							
						2100						TM1-1521	TM1-1821	TM1-2121	TM2-2121	TM3-2121
						2400						TM1-1524	TM1-1824	TM1-2124	TM2-2124	TM3-2124
2700						TM2-1524	TM2-1824	TM4-2124	TM5-2124	TM6-2124						
						TM1-1527	TM1-1827	TM1-2127	TM2-2127	TM3-2127						
注：推拉门不应用于疏散门，且门扇净宽度不宜小于700，高度不宜大于2400。						推拉全玻门立面图					图集号	12YJ4-1				
											页次	6				

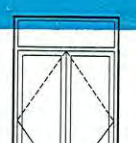
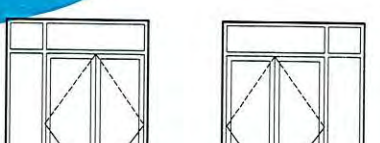
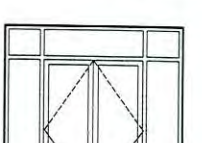

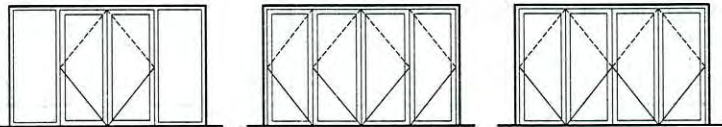
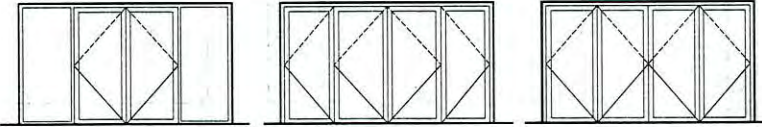
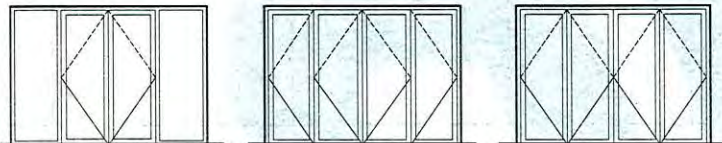
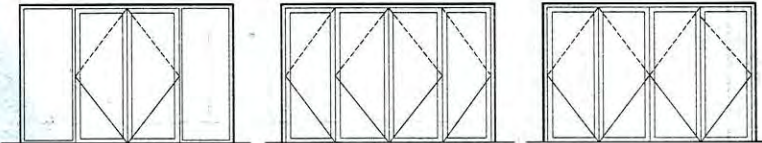
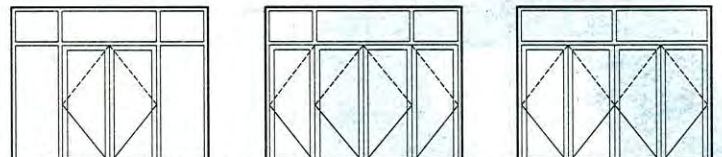
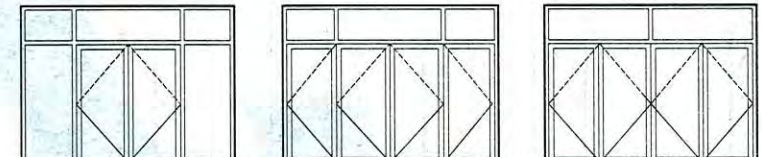
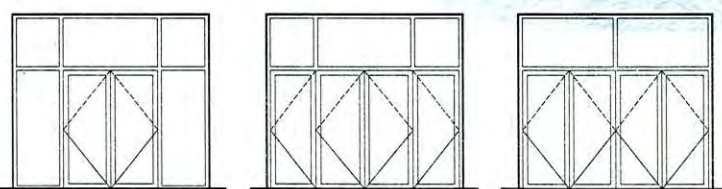
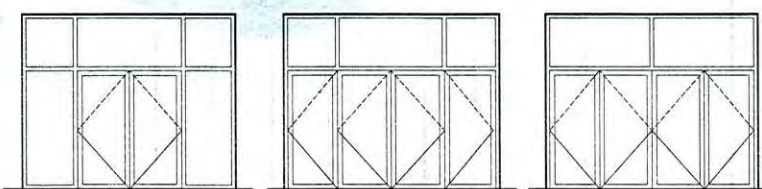







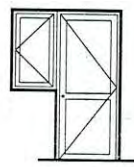
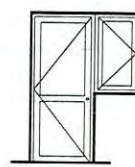
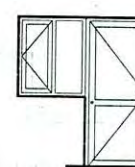

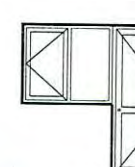

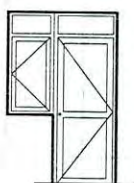
张 晓 洁 审 核 刘 鹰 凤 对 校 郝 晓 丹 设 计 郝 晓 丹 制 图	洞宽	900	1000	1500	1800	2400	3000
	2100	 HM1-0921 HM2-0921	 HM1-1021 HM2-1021	 HM-1521	 HM-1821	 HM1-2421 HM2-2421	 HM-3021
	2400	 HM1-0924 HM2-0924	 HM1-1024 HM2-1024	 HM-1524	 HM-1824	 HM1-2424 HM2-2424	 HM-3024
	2700	 HM1-0927 HM2-0927	 HM1-1027 HM2-1027	 HM-1527	 HM-1827	 HM1-2427 HM2-2427	 HM-3027
	3000	 HM1-0930 HM2-0930	 HM1-1030 HM2-1030	 HM-1530	 HM-1830	 HM1-2430 HM2-2430	 HM-3030
注：地弹簧门门扇净宽度不宜小于700，高度不宜大于2400。						地弹簧门立面图(一)	
						图集号	12YJ4-1
						页次	7

制图 郝晓丹 设计 郝晓丹 校对 郝晓丹 审核 刘鹰凤 张晚浩	3300  HM1-3321      HM2-3321      HM3-3321	3600  HM1-3621      HM2-3621      HM3-3621
	 HM1-3324      HM2-3324      HM3-3324	 HM1-3624      HM2-3624      HM3-3624
	 HM1-3327      HM2-3327      HM3-3327	 HM1-3627      HM2-3627      HM3-3627
	 HM1-3330      HM2-3330      HM3-3330	 HM1-3630      HM2-3630      HM3-3630



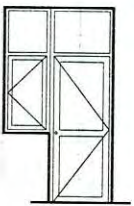



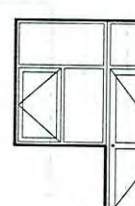
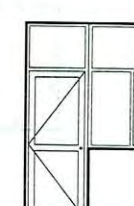

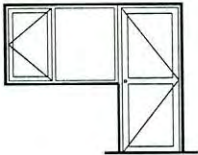
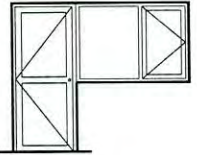
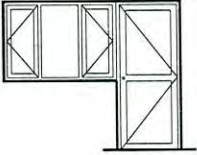
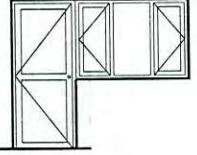
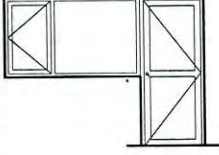
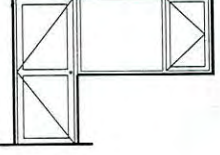
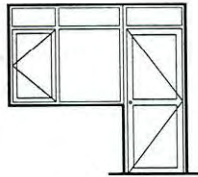
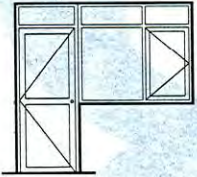
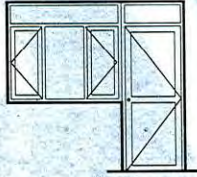
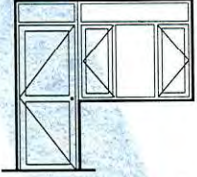
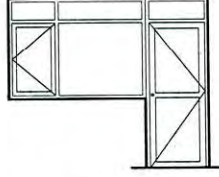
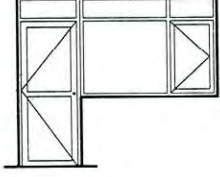
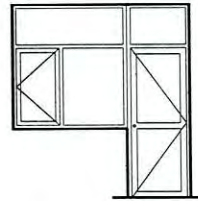
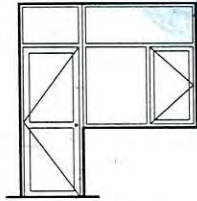
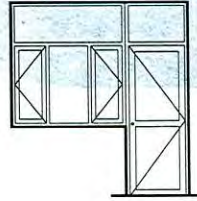
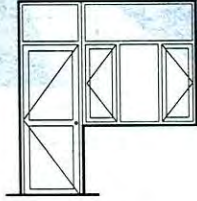
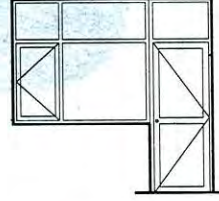
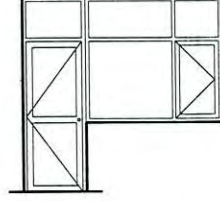
注：地弹簧门门扇净宽度不宜小于700，高度不宜大于2400。

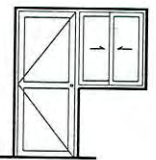
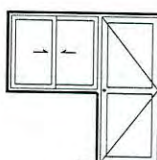
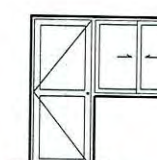
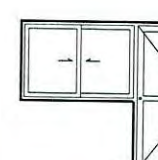
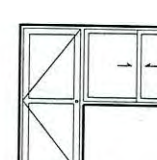
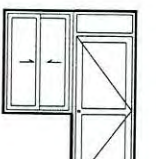
地弹簧门立面图(二)



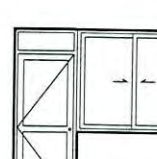
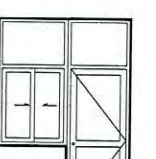



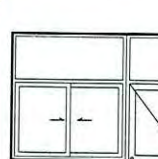
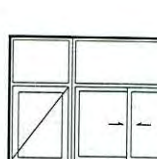





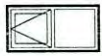
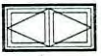
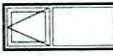
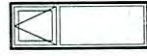
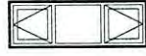







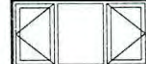



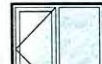





图集号	12YJ4-1
页次	8











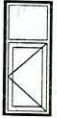
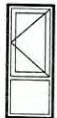
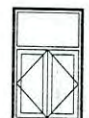
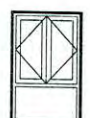
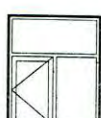
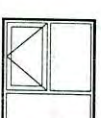
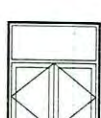
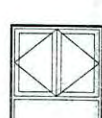
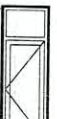

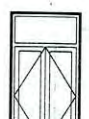



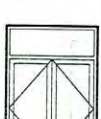

制 图	郝晓丹 郝晓丹	设 计	郝晓丹 郝晓丹	校 对	刘鹰岚 刘鹰岚	审 核	张 晓 洁	洞宽	1500	1800	2100	
								洞高	2100	2400	2700	
								 MPC1-1521  MPC2-1521	 MPC1-1821  MPC2-1821	 MPC1-2121  MPC2-2121		
 MPC1-1524  MPC2-1524	 MPC1-1824  MPC2-1824	 MPC1-2124  MPC2-2124										
 MPC1-1527  MPC2-1527	 MPC1-1827  MPC2-1827	 MPC1-2127  MPC2-2127										
注：1. 平开窗的开启扇，其净宽不宜大于600，净高不宜大于1400。 2. 门扇净高不宜大于2400。								平开门连窗立面图(一)			图集号	12YJ4-1
											页次	9

张 晓 洁 核 对 刘 鹰 岚 校 对 郝 晓 丹 设 计 郝 晓 丹 制 图	洞宽	2400				2700	
	2100	 MPC1-2421	 MPC2-2421	 MPC3-2421	 MPC4-2421	 MPC1-2721	 MPC2-2721
	2400	 MPC1-2424	 MPC2-2424	 MPC3-2424	 MPC4-2424	 MPC1-2724	 MPC2-2724
2700	 MPC1-2427	 MPC2-2427	 MPC3-2427	 MPC4-2427	 MPC1-2727	 MPC2-2727	
注：1. 平开窗的开启扇，其净宽不宜大于600，净高不宜大于1400。 2. 门扇净高不宜大于2400。					平开门连窗立面图(二)		
					图集号	12YJ4-1	
					页次	10	

制 图 郝晓丹 设计 郝晓丹 校对 刘鹰岚 审核 张晚洁	净高	1800	2100	2400			
	2100	 MTC1-1821	 MTC2-1821	 MTC1-2121	 MTC2-2121	 MTC1-2421	 MTC2-2421
	2400	 MTC1-1824	 MTC2-1824	 MTC1-2124	 MTC2-2124	 MTC1-2424	 MTC2-2424
	2700	 MTC1-1827	 MTC2-1827	 MTC1-2127	 MTC2-2127	 MTC1-2427	 MTC2-2427
	净宽	注：1. 推拉窗的开启扇，其净宽不宜大于900，净高不宜大于1500。 2. 门扇净高不宜大于2400。		平开门连推拉窗立面图		图集号 12YJ4-1	页次 11

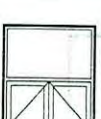

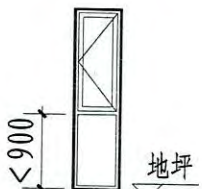

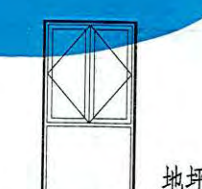







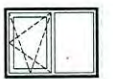
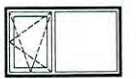
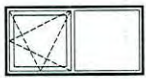
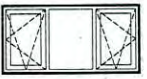
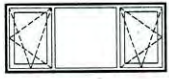



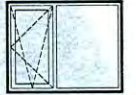

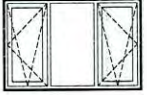
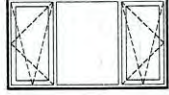

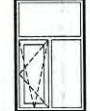
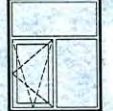

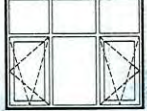
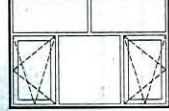
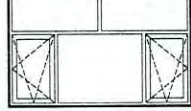

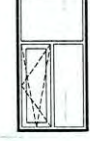
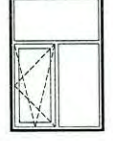
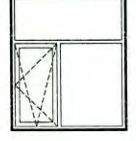
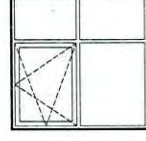
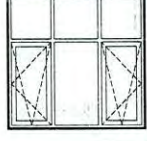
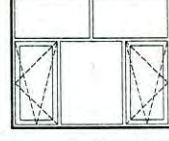
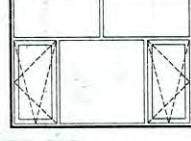





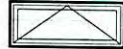



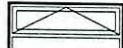





















张晚洁 核 申 刘鹰岚 校 对 王玉珏 计 设 王玉珏 制 图	净宽	600	900	1200	1500	1800	2100	2400	
	600	 PC-0606	 PC-0906	  PC1-1206    PC2-1206	 PC-1506	  PC1-1806    PC2-1806	 PC-2106	 PC-2406	
	900	 PC-0609	 PC-0909	  PC1-1209    PC2-1209	 PC-1509	  PC1-1809    PC2-1809	 PC-2109	 PC-2409	
	1200	 PC-0612	 PC-0912	  PC1-1212    PC2-1212	 PC-1512	  PC1-1812    PC2-1812	 PC-2112	 PC-2412	
1400	 PC-0614	 PC-0914	  PC1-1214    PC2-1214	 PC-1514	  PC1-1814    PC2-1814	 PC-2114	 PC-2414		
注：平开窗的开启扇，其净宽不宜大于600，净高不宜大于1400。						平开窗立面图（一）			图集号 12YJ4-1 页次 12











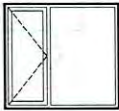
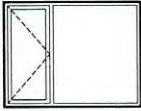
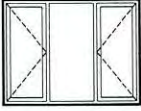

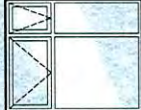
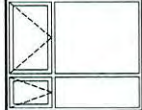
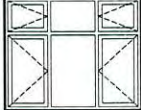
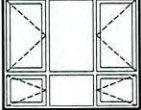
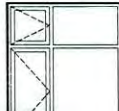
制 图	王 玉 珏	王 玉 珏	设 计	王 玉 珏	校 对	刘 鹰 岚	申 核	张 晓 洁	净高	净宽	600	900	1200				
									1500	 PC1-0615	 PC2-0615	 PC1-0915	 PC2-0915	 PC1-1215	 PC2-1215	 PC3-1215	 PC4-1215
									1800	 PC1-0618	 PC2-0618	 PC1-0918	 PC2-0918	 PC1-1218	 PC2-1218	 PC3-1218	 PC4-1218
									2100	 PC1-0621	 PC2-0621	 PC1-0921	 PC2-0921	 PC1-1221	 PC2-1221	 PC3-1221	 PC4-1221
									2400	 PC-0624	 PC-0924	 PC-1224					
注：1. 平开窗的开启扇，其净宽不宜大于600，净高不宜大于1400。 2. 落地窗玻璃横档高度及抗水平推力应满足规范要求。									平开窗立面图(二)				图集号	12YJ4-1			
													页次	13			

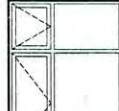

张皓洁 张皓洁	审核	刘鹰岚 刘鹰岚	校对	王玉珏 王玉珏	设计	王玉珏 王玉珏	制图	2100	2400
1500	PC1-2115	PC2-2115	PC3-2115	PC4-2115	PC5-2115	PC6-2115	PC1-2415	PC2-2415	
1800	PC1-2118	PC2-2118	PC3-2118	PC4-2118	PC5-2118	PC6-2118	PC1-2418	PC2-2418	
2100	PC1-2121	PC2-2121	PC3-2121	PC4-2121	PC5-2121	PC6-2121	PC1-2421	PC2-2421	
2400 120 < 900	PC1-2124	PC2-2124					PC-2424	地坪	
注：1. 平开窗的开启扇，其净宽不宜大于600，净高不宜大于1400。 2. 落地窗玻璃横档高度及抗水平推力应满足规范要求。							平开窗立面图(四)		图集号 12YJ4-1 页次 15

张 晓 洁 刘 鹰 岚 王 玉 珏 王 玉 珏 制 图 设 计 校 对 审 核	900	600	900	1200	1500	1800	2100	2400
	 PXC-0609	 PXC-0909	 PXC-1209	 PXC-1509	 PXC1-1809	 PXC2-1809	 PXC-2109	 PXC-2409
	 PXC-0612	 PXC-0912	 PXC-1212	 PXC-1512	 PXC1-1812	 PXC2-1812	 PXC-2112	 PXC-2412
	 PXC-0615	 PXC-0915	 PXC-1215	 PXC-1515	 PXC1-1815	 PXC2-1815	 PXC-2115	 PXC-2415
1800	 PXC-0618	 PXC-0918	 PXC-1218	 PXC-1518	 PXC1-1818	 PXC2-1818	 PXC-2118	 PXC-2418
注：窗的开启扇，其净宽不宜大于800，净高不宜大于1500。						内平开下悬窗立面图		图集号 12YJ4-1 页次 16

张晚洁 张晚洁		600	900	1200	1500							
审核	600	 SXC-0606	 SXC-0906	 SXC-1206	 SXC-1506							
刘鹰凤 刘鹰凤	900	 SXC-0609	 SXC-0909	 SXC1-1209	 SXC2-1209	 SXC-1509						
王玉珏 王玉珏	1200	 SXC1-0612	 SXC2-0612	 SXC3-0612	 SXC1-0912	 SXC2-0912	 SXC3-0912	 SXC1-1212	 SXC2-1212	 SXC-1512		
制图	1500	 SXC1-0615	 SXC2-0615	 SXC3-0615	 SXC1-0915	 SXC2-0915	 SXC3-0915	 SXC1-1215	 SXC2-1215	 SXC3-1215	 SXC1-1515	 SXC2-1515
	1800	 SXC1-0618	 SXC2-0618	 SXC3-0618	 SXC1-0918	 SXC2-0918	 SXC3-0918	 SXC1-1218	 SXC2-1218	 SXC3-1218	 SXC1-1518	 SXC2-1518
上悬窗立面图										图集号	12YJ4-1	
										页次	17	

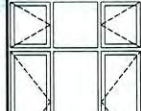
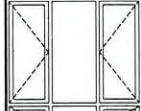
制图 王玉琨 设计 王玉琨 校对 刘鹰岚 审核 张晚洁	1800	1500		1800					
	1400	 DPC-1514		 DPC1-1814		 DPC2-1814			
	1500	 DPC1-1515	 DPC2-1515	 DPC1-1815	 DPC2-1815	 DPC3-1815	 DPC4-1815		
	1800	 DPC1-1518	 DPC2-1518	 DPC1-1818	 DPC2-1818	 DPC3-1818	 DPC4-1818		
	2100	 DPC1-1521	 DPC2-1521	 DPC1-1821	 DPC2-1821	 DPC3-1821	 DPC4-1821		

注：平开窗的开启扇，其净宽不宜大于600，净高不宜大于1400。

内开叠合窗立面图(一)

张晚洁 刘鹰凤 王玉珏 王玉珏 王玉珏 王玉珏	审核 刘鹰凤 王玉珏	2100 1400 2100	2400 1500 1800 2100	2100 1400 1500 1800 2100	2400 1400 1500 1800 2100
	设计 王玉珏 王玉珏	2100 1400 1500 1800 2100	2400 1400 1500 1800 2100	2100 1400 1500 1800 2100	2400 1400 1500 1800 2100
	校对 王玉珏 王玉珏	2100 1400 1500 1800 2100	2400 1400 1500 1800 2100	2100 1400 1500 1800 2100	2400 1400 1500 1800 2100
	制图 王玉珏 王玉珏	2100 1400 1500 1800 2100	2400 1400 1500 1800 2100	2100 1400 1500 1800 2100	2400 1400 1500 1800 2100
	张晚洁 刘鹰凤 王玉珏 王玉珏 王玉珏 王玉珏	2100 1400 1500 1800 2100	2400 1400 1500 1800 2100	2100 1400 1500 1800 2100	2400 1400 1500 1800 2100

注：平开窗的开启扇，其净宽不宜大于600，净高不宜大于1400。

内开叠合窗立面图(二)

图集号	12YJ4-1
页次	19























































制图 王玉珏	设计 王玉珏	校对 王玉珏	审核 刘鹰岚	张瑞洁	600	900	1200	1500	1800	2100
					600	900	1200	1500	1800	2100
					GC-0606	GC-0906	GC-1206	GC1-1506 GC2-1506	GC1-1806 GC2-1806	GC1-2106 GC2-2106
					GC-0609	GC-0909	GC-1209	GC1-1509 GC2-1509	GC1-1809 GC2-1809	GC1-2109 GC2-2109
					GC-0612	GC-0912	GC-1212	GC1-1512 GC2-1512	GC1-1812 GC2-1812	GC1-2112 GC2-2112
					GC1-0614 GC2-0614	GC1-0914 GC2-0914	GC1-1214 GC2-1214	GC1-1514 GC2-1514	GC1-1814 GC2-1814	GC1-2114 GC2-2114
1500	GC1-0615 GC2-0615	GC1-0915 GC2-0915	GC1-1215 GC2-1215	GC1-1515 GC2-1515	GC1-1815 GC2-1815	GC1-2115 GC2-2115				



























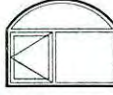
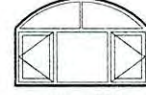



注：固定窗可供单独选用，也可供拼接时选用。

固定窗立面图

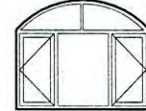
图集号 12YJ4-1

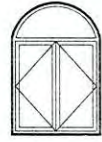
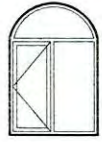

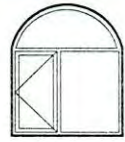
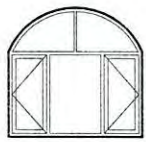
页次 20

制 图		王 玉 珏	设 计	王 玉 珏	校 对	刘 鹰 凤	核 审	张 晓 洁				
								高	宽			
								900	1200	1500	1800	2100
600		 TC-0906	 TC-1206	 TC-1506	 TC-1806	 TC1-2106	 TC2-2106					
900		 TC-0909	 TC-1209	 TC-1509	 TC-1809	 TC1-2109	 TC2-2109					
1200		 TC1-0912	 TC2-0912	 TC1-1212	 TC2-1212	 TC1-1512	 TC2-1512	 TC1-1812	 TC2-1812	 TC1-2112	 TC2-2112	
1500		 TC1-0915	 TC2-0915	 TC1-1215	 TC2-1215	 TC1-1515	 TC2-1515	 TC1-1815	 TC2-1815	 TC1-2115	 TC2-2115	
1800		 TC1-0918	 TC2-0918	 TC1-1218	 TC2-1218	 TC1-1518	 TC2-1518	 TC1-1818	 TC2-1818	 TC1-2118	 TC2-2118	
2100		 TC1-0921	 TC2-0921	 TC1-1221	 TC2-1221	 TC1-1521	 TC2-1521	 TC1-1821	 TC2-1821	 TC1-2121	 TC2-2121	
注：推拉窗的开启扇，其净宽不宜大于900，净高不宜大于1500。										图集号 12YJ4-1		页次 21
推拉窗立面图												

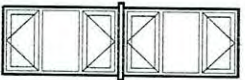
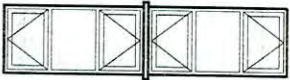
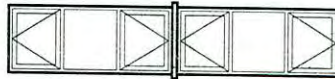
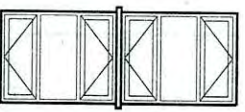

制图 王玉珏 设计 王玉珏 校对 刘鹰岚 审核 张皓洁	窗高	900	1200	1500	1800
	窗宽	900	1200	1500	1800
	900	 YC1-0909  YC2-0909	 YC1-1209	 YC1-1509  YC2-1509  YC3-1509	 YC1-1809  YC2-1809  YC3-1809  YC4-1809
	1200	 YC-0912	 YC1-1212  YC2-1212  YC3-1212  YC4-1212  YC5-1212	 YC-1512	 YC-1812
	1500	 YC-0915	 YC1-1215  YC2-1215	 YC1-1515  YC2-1515  YC3-1515  YC4-1515	 YC-1815
1800	 YC-0918	 YC1-1218  YC2-1218  YC3-1218	 YC-1518	 YC1-1818  YC2-1818	

注：异形窗用于顶层立面装饰及老虎窗。窗上部固定亮子的高度由设计人定，但一般不大于1/2洞口宽度。

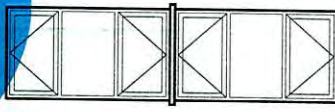
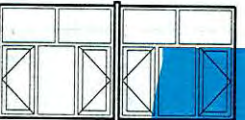
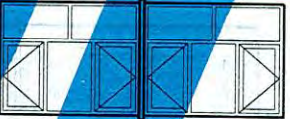
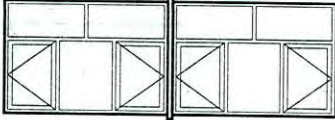
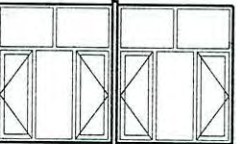
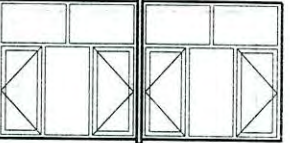
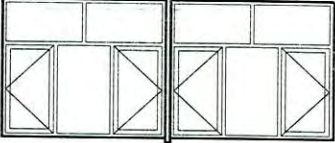

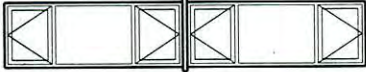
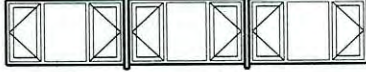
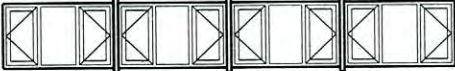

异形窗立面图

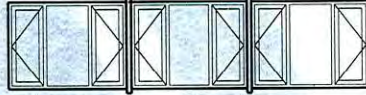
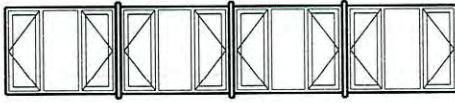
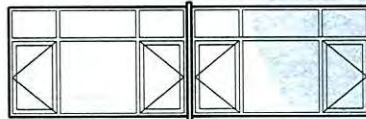
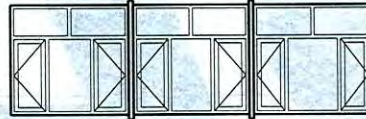
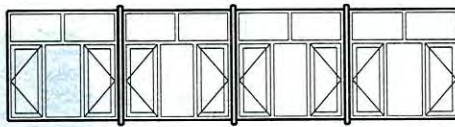
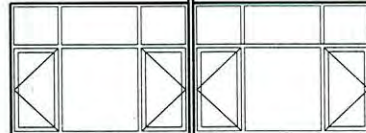
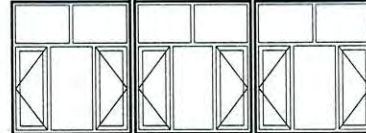
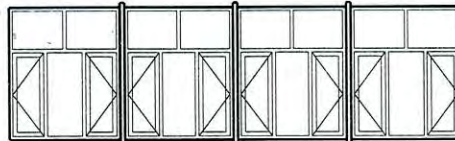
张陈洁 刘鹰岚 王玉珏 王玉珏 制图	3000  ZPC-3009	3600  ZPC-3609	4200  ZPC-4209
	900  ZPC-3012	 ZPC-3612	 ZPC-4212
	1200  ZPC-3015	 ZPC-3615	 ZPC-4215
	1500  ZPC-3018	 ZPC-3618	 ZPC-4218
1800			
注：1. 组合窗的拼料应核算风压值以后进行选择。2. 平开窗的开启扇，其净宽不宜大于600，净高不宜大于1400。3. 用于外窗时，拼樘料采用隔热型材。			图集号 12YJ4-1 页次 23

平开组合窗立面图(一)

制图 王玉珏 设计 王玉珏 校对 刘鹰凤 审核 张晚洁	窗高	4800	6000
	900	 ZPC1-4809  ZPC2-4809	 ZPC-6009
	1200	 ZPC1-4812  ZPC2-4812	 ZPC-6012
	1500	 ZPC1-4815  ZPC2-4815	 ZPC-6015
	1800	 ZPC1-4818  ZPC2-4818	 ZPC-6018
注：1. 组合窗的拼料应核算风压值以后进行选择。2. 平开窗的开启扇，其净宽不宜大于600，净高不宜大于1400。3. 用于外窗时，拼樘料采用隔热型材。		平开组合窗立面图(二)	
		图集号	12YJ4-1
		页次	24

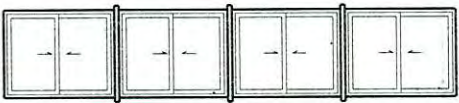
张皖洁 张皖洁	审核	刘鹰岚 刘鹰岚	校对	王玉珏 王玉珏	设计	王玉珏 王玉珏	制图	净高/净宽	3000	3600	4200
								1200	ZTC-3012	ZTC-3612	ZTC-4212
								1500	ZTC-3015	ZTC-3615	ZTC-4215
								1800	ZTC-3018	ZTC-3618	ZTC-4218
注：1. 组合窗的拼料应核算风压值以后进行选择。2. 推拉窗的开启扇，其净宽不宜大于900，净高不宜大于1500。3. 用于外窗时，拼樘料采用隔热型材。									推拉组合窗立面图(一)		图集号 12YJ4-1 页次 25

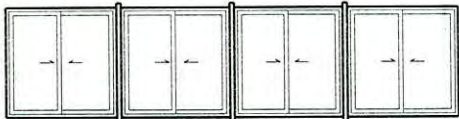
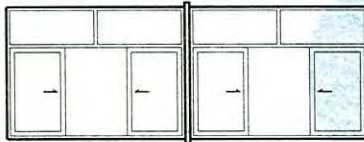
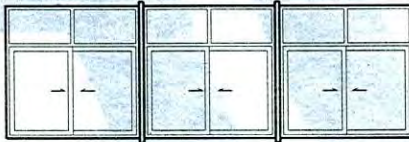
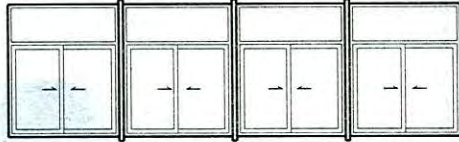
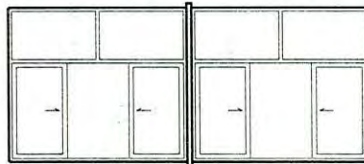
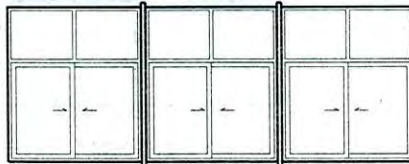
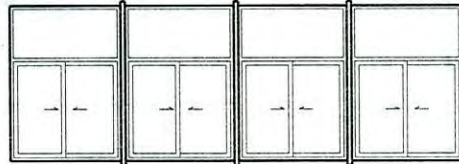
张晚洁 刘鹰岚 王玉珏 王玉珏 王玉珏 王玉珏	审核	张晚洁	校对	刘鹰岚	设计	王玉珏	制图	王玉珏
	1200	4800	5400	6000	 ZTC-4812	 ZTC-5412	 ZTC-6012	
	1500	 ZTC-4815	 ZTC-5415	 ZTC-6015				
	1800	 ZTC-4818	 ZTC-5418	 ZTC-6018				
	2100	 ZTC-4821	 ZTC-5421	 ZTC-6021				
注：1. 组合窗的拼料应核算风压值以后进行选择。2. 推拉窗的开启扇，其净宽不宜大于900，净高不宜大于1500。3. 用于外窗时，拼樘料采用隔热型材。								
推拉组合窗立面图(二)							图集号 12YJ4-1 页次 26	

张 晓 洁	张 晓 洁
核 审	
刘 鹰 凤	刘 鹰 凤
对 校	
曹 越	曹 越
计 设	
曹 越	曹 越
图 制	

## A型-铝合金门窗说明

### 1. 编制依据

《铝合金门窗》 (GB/T 8478-2008)

《铝合金门窗工程技术规范》 (JGJ 214-2010)

### 2. 编制内容

2.1 外平开门、推拉门、弹簧门、内平开下悬窗、外平开窗、推拉窗的构造节点示意图。

2.2 组合窗、连窗门拼接安装节点图、基本门窗安装节点图。

2.3 本图集节点图以中空玻璃、单层玻璃、三层玻璃表示，具体选用可根据工程需要确定。

### 3. 适用范围及特点

3.1 适用范围：铝合金门窗广泛用于公共建筑与居住建筑，为满足节能要求将框料做成带隔断层的，断热铝型材可选用硬质塑料隔热条式，也可选用注胶式。

3.2 技术特点：铝合金门窗采用铝合金挤压型材为框、梃、扇料制作的门窗，具有质轻高强、不易变形、密封性较好、美观等特点。

### 4. 技术要求

#### 4.1 型材：

4.1.1 铝合金门窗用主型材壁厚应经计算或试验确定，其中门窗型材截面主要受力部位最小实测壁厚不应小于2.0mm，窗用型材截面主要受力部位最小实测壁厚不应小于1.4mm。

4.1.2 铝合金型材表面处理应符合下列规定：

(1) 氟碳漆喷涂型材：二涂层氟碳漆膜，装饰面平均漆膜厚度不

应小于30 $\mu$ m。

(2) 粉末喷涂型材：装饰面上涂层最小局部厚度应大于40 $\mu$ m。

(3) 电泳涂漆型材：阳极氧化复合膜，表面漆膜采用透明漆应符合B级要求。复合膜局部膜厚不应小于16 $\mu$ m。

(4) 阳极氧化型材：阳极氧化膜膜厚度应符合AA15级要求。

凡有酸雨及沿海地区，以选用前三种表面处理型材为宜。

### 4.2 玻璃

可采用浮法玻璃、着色玻璃、镀膜玻璃、中空玻璃、真空玻璃、钢化玻璃、夹层玻璃、夹丝玻璃等。

玻璃厚度一般为5mm或6mm。

所用玻璃若采用真空磁控溅射法（离线法）生产的Low-E玻璃，应合成中空玻璃使用，中空玻璃合片时，应去除玻璃边部与密封胶粘接部位的镀膜，Low-E膜层应位于中空气体层内；热喷涂法（在线法）生产的Low-E玻璃可单片使用，Low-E膜层宜面向室内。

(2) 门、窗玻璃应符合现行《建筑玻璃应用技术规程》的要求。

### 4.3 密封材料：

铝合金门窗用密封胶条应符合现行行业标准《建筑门窗用密封胶条》JG/T187的规定，密封胶条宜使用硫化橡胶类材料或热塑性弹性体类材料。

铝合金门窗用密封毛条应符合现行行业标准《建筑门窗密封毛条技术条件》JC/T635的规定，毛条的毛束应经过硅化处理，宜使用加片型密封毛条。

A型-铝合金门窗说明（一）

图集号

12YJ4-1

页次

27



张	晓	洁
核	审	
刘	凤	
对	校	
曹	越	
计	设	
曹	越	
制	图	

#### 4.4 五金配件

4.4.1 五金件应满足门窗功能要求和耐久性要求，合页、滑撑、滑轮等五金件的选用应满足门窗承载力要求，五金件应符合现行行业标准《建筑门窗五金件 通用要求》JG/T212的规定。

4.4.2 铝合金门窗工程连接用螺钉、螺栓宜使用不锈钢紧固件。

4.4.3 铝合金门窗五金件、紧固件用钢材宜采用奥氏体不锈钢材料，黑色金属材料根据使用要求应选用热浸镀锌、电镀锌、防锈涂料等有效防腐处理。

4.5 门、窗组装尺寸允许偏差应符合表4.6的规定。

表 4.5 门窗组装尺寸允许偏差 (mm)

项目	尺寸范围	允许偏差	
		门	窗
门窗宽度、高度 构造内侧尺寸	$L < 2000$	±1.5	
	$2000 < L \leq 3500$	±2.0	
	$L \geq 3500$	±2.5	
门窗宽度、高度构 造内侧对边尺寸差	$L < 2000$	+2.0 0.0	
	$2000 \leq L < 3500$	+3.0 0.0	
	$L \geq 3500$	+4.0 0.0	
门窗框、扇搭接宽度	—	±2.0	±1.0
型材框、扇杆件接缝 表面高低差	相同截面型材	±0.3	
	不同截面型材	±0.5	
型材框、扇杆件 装配间隙	—	+0.3 0.0	

4.6 防雷设计，应符合现行国家标准《建筑物防雷设计规范》GB50057的规定，铝合金门窗的框架应与主体结构的防雷装置可靠连接。

#### 5. 包装、运输、贮存

包装、运输、贮存应符合《铝合金门窗》GB/T8478。

#### 6. 安装施工

6.1 不得采用边砌口边安装或先安装后砌口的施工方法，宜采用干法施工方式。

6.2 铝合金门窗安装宜采用干法施工方式。

6.3 铝合金门窗的安装施工宜在室内侧或洞口内进行。

6.4 门窗应启闭灵活、无卡滞。

6.5 复核建筑门窗洞口尺寸，洞口宽、高尺寸允许偏差应为±10mm，对角线尺寸允许偏差应为±10mm。

6.6 门窗安装位置、开启方向与安装连接方式应符合本图集规定和建筑工程施工要求。

6.7 门、窗框与墙体需要用保温材料填充时，应连接牢固。

6.8 铝合金门窗采用干法施工安装时，应符合下列规定：

(1) 金属附框安装应在洞口及墙体抹灰湿作业前完成，铝合金门窗安装应在洞口及墙体抹灰湿作业后进行。

(2) 金属附框宽度应大于30mm。

(3) 金属附框的内、外两侧宜采用固定片与洞口墙体连接固定；固定片宜用Q235钢材，厚度不应小于1.5mm，宽度不应小于20mm，表面应做防腐处理。

(4) 金属附框固定片安装位置应满足：角部的距离不应大于150mm，

张晓洁  
核  
审  
刘鹰凤  
对  
校  
曹越  
计  
曹越  
制  
图

其余部位的固定片中心距不应大于500mm；固定片与墙体固定点的中心位置至墙体边缘距离不应小于50mm。

(5) 金属附框宽度和高度允许尺寸偏差及对角线允许尺寸偏差应符合表6.8的规定。

表 6.8 金属附框尺寸允许偏差 (mm)

项目	允许偏差值	检测方法
金属附框高、宽偏差	±3.0	钢卷尺
对角线尺寸偏差	±4.0	钢卷尺

6.9 铝合金门窗安装就位后，边框与墙体之间应作好密封防水处理，并应符合下列要求：

- (1) 应采用粘接性能良好并相容的耐候密封胶。
- (2) 打胶前应清洁粘接表面，去除灰尘、油污，粘接面应保持干燥，墙体部位应平整洁净。
- (3) 胶缝采用矩形截面胶缝时，密封胶有效厚度应大于6mm，采用三角形截面胶缝时，密封胶截面宽度应大于8mm。
- (4) 注胶应平整密实，胶缝宽度均匀、表面光滑、整洁美观。

#### 7. 施工、验收、检验

铝合金门窗工程验收即检验应符合现行国家标准《建筑工程施工质量验收统一标准》GB50300、《建筑装饰装修工程质量验收规范》GB50210及《建筑节能工程施工质量验收规范》GB50411的有关规定。

#### 8. 保养与维护

8.1 铝合金门窗工程竣工验收时，应提供门窗产品维护说明书。

8.2 铝合金门窗维修人员应进行培训。

8.3 日常维护和保养应符合下列规定：

- (1) 铝合金门窗应在通风、干燥的环境中使用，保持门窗表面整洁，不得与酸、碱、盐等有腐蚀性的物质接触。
- (2) 铝合金门窗宜用中性的水溶洗涤剂清洗，不得使用有腐蚀性的化学剂。
- (3) 门窗的排水系统应定期检查，清除堵塞物，保持畅通。
- (4) 门窗滑槽、传动机构、合页、滑撑、执手等部位应保持清洁，去除灰尘。
- (5) 门窗铰链、滑轮、执手等门窗五金件应定期进行检查和润滑，保持开启灵活，无卡滞，五金件损坏应及时更换，启闭不灵活应及时修理。
- (6) 铝合金门窗密封条、密封毛条出现破损、老化或缩短时应及时修补或更换。

张	晓	洁
核	审	
刘	鹰	凤
对	校	
郝	晓	丹
计	设	
郝	晓	丹
图	制	

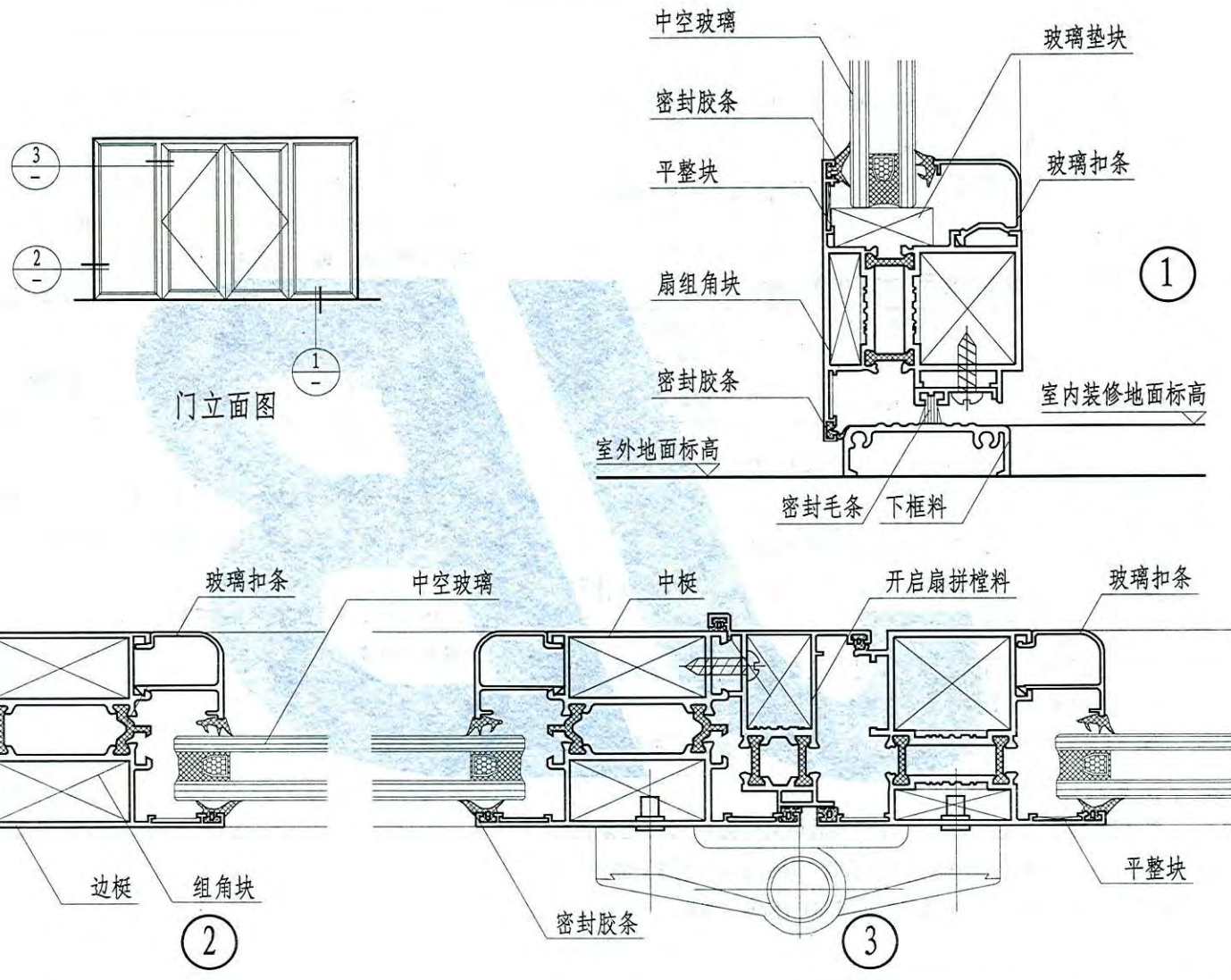

A型-铝合金外平开门节点图		图集号	12YJ4-1
		页次	30

张 晓 洁  
核 审  
刘 鹰 凤  
对 校  
郝 晓 丹  
设 计  
郝 晓 丹  
制 图

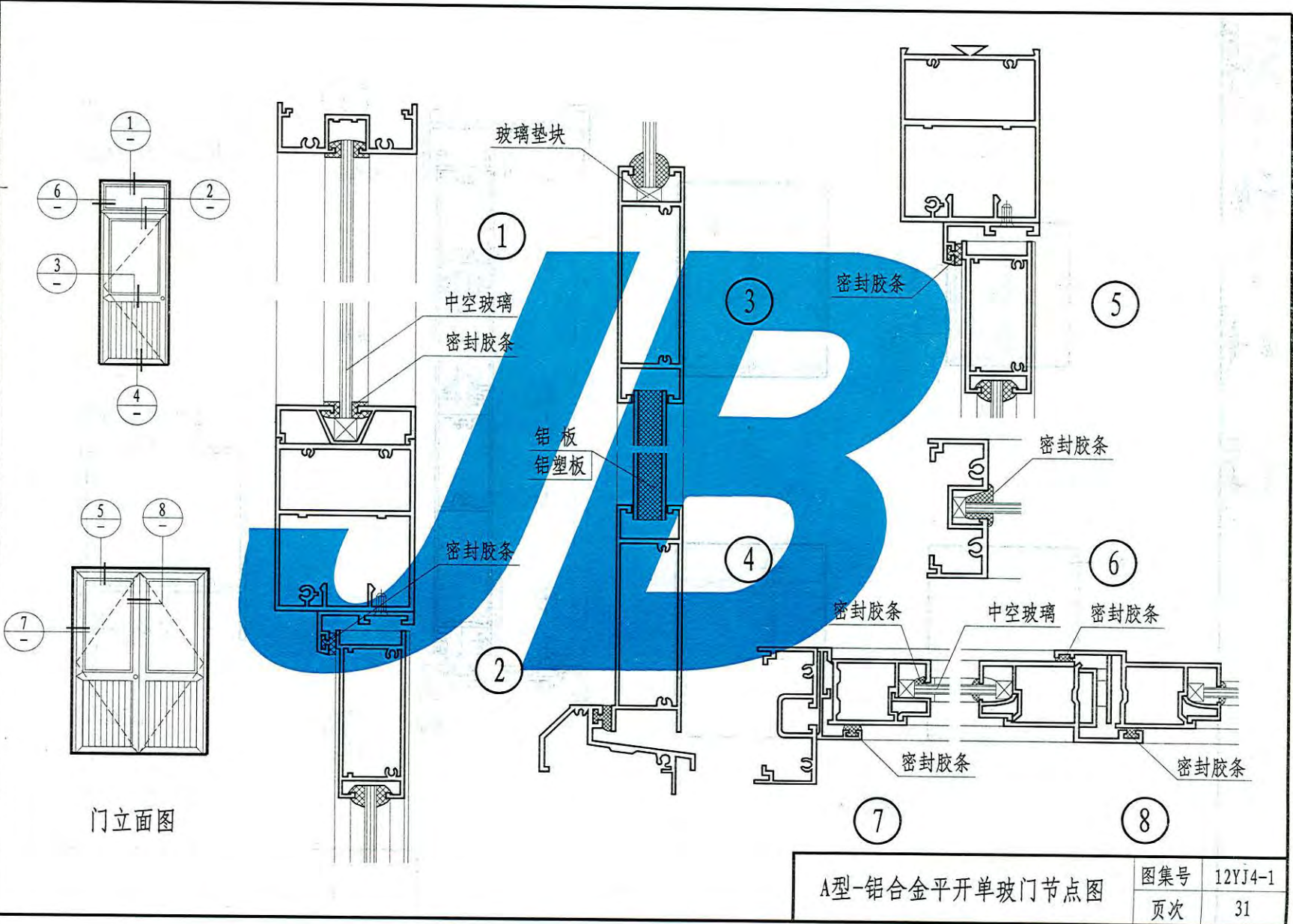

A型-铝合金平开单玻门节点图

图集号	12YJ4-1
页次	31

制	郝晓丹	设计	郝晓丹	校对	郝晓丹	审核	刘鹰凤	张晚洁
图	郝晓丹	设	郝晓丹	校	郝晓丹	审	刘鹰凤	张晚洁

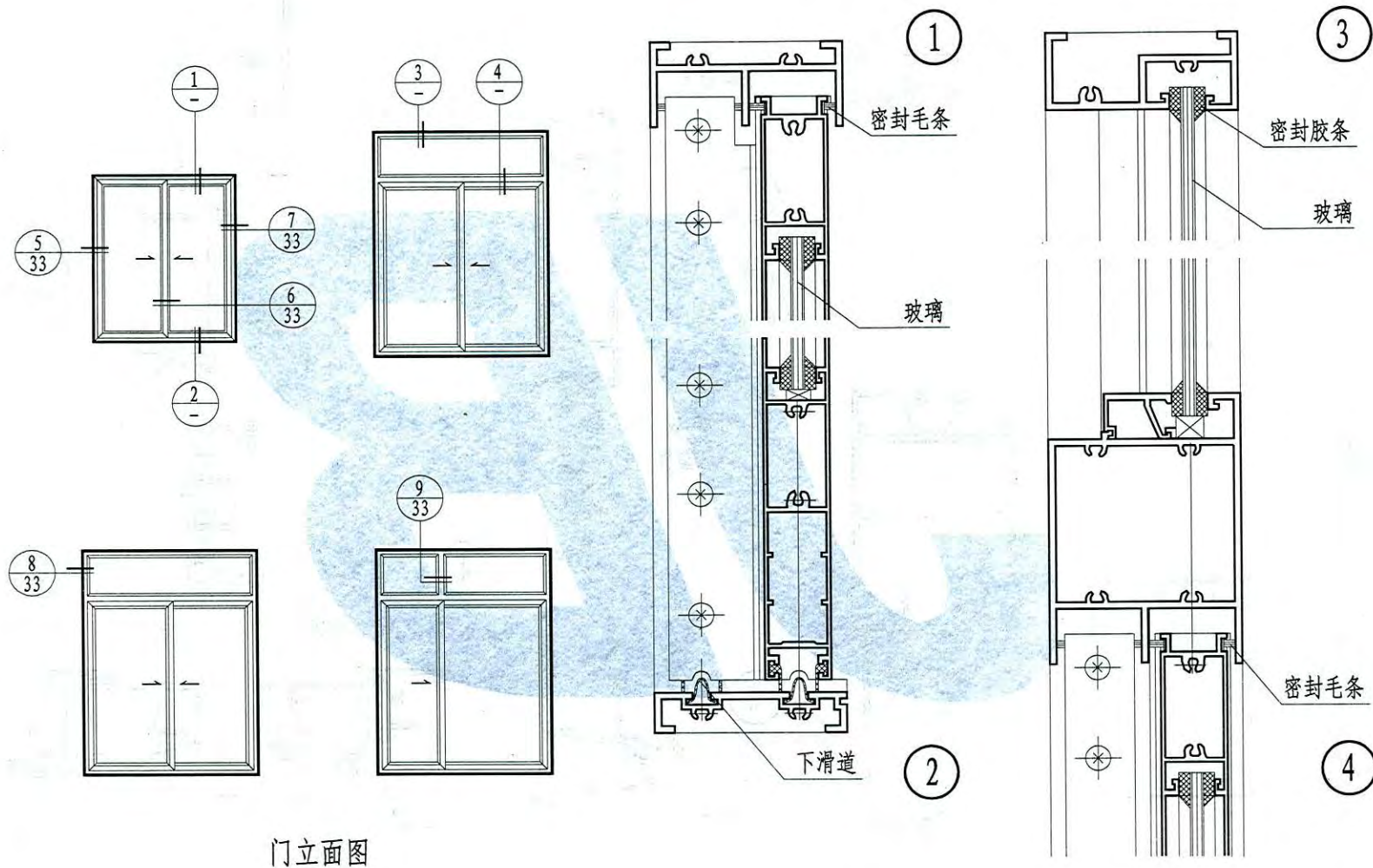

门立面图

A型-铝合金推拉  
单玻门节点图(一)

图集号	12YJ4-1
页次	32

制图	郝晓丹
设计	郝晓丹
校对	郝晓丹
审核	刘鹰岚
张晓洁	张

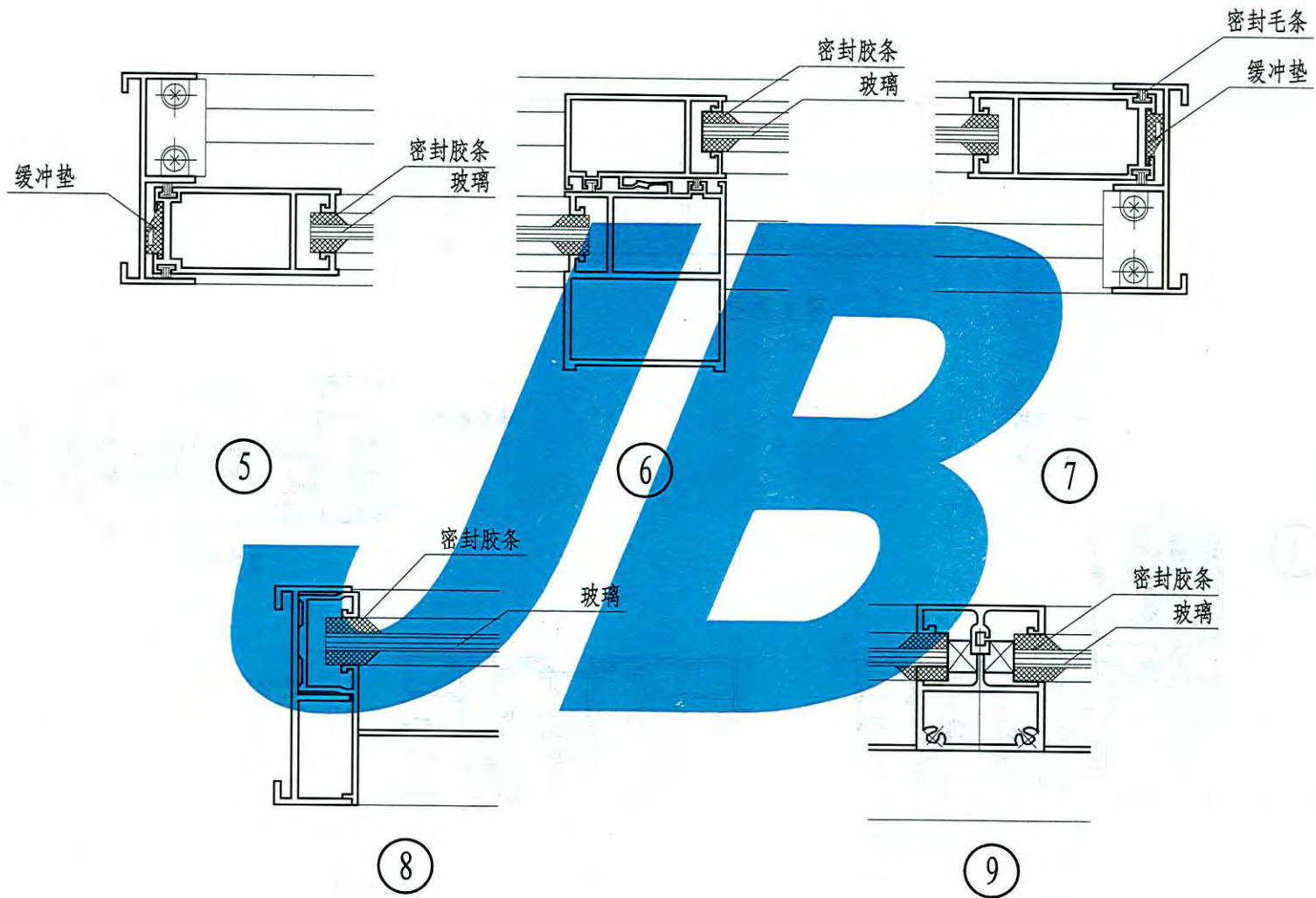

A型-铝合金推拉 单玻门节点图(二)		图集号	12YJ4-1
		页次	33

张 晓 洁  
 核 审  
 刘 鹰 岚  
 对 校  
 郝 晓 丹  
 计 设  
 郝 晓 丹  
 图 制

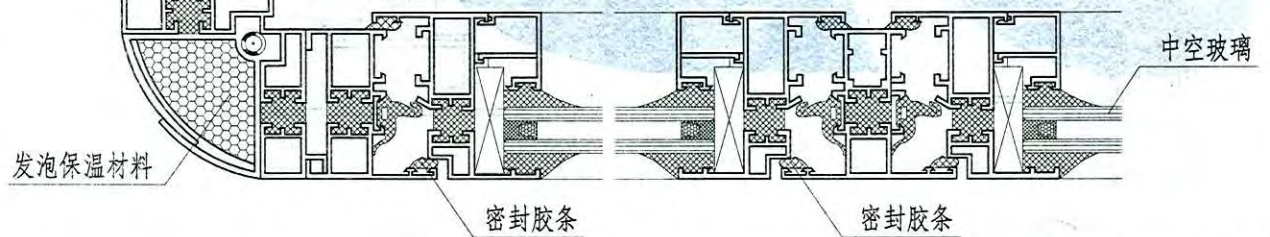
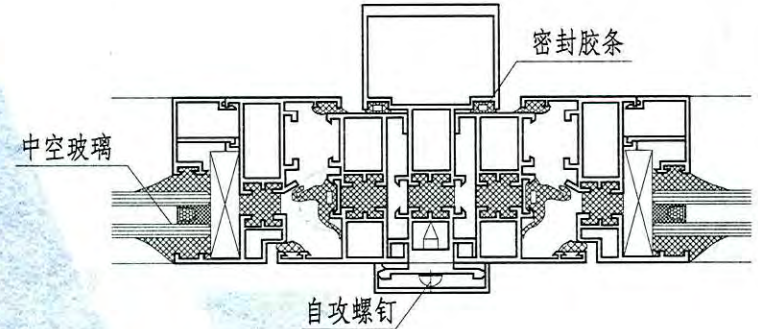
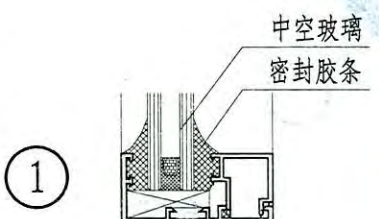
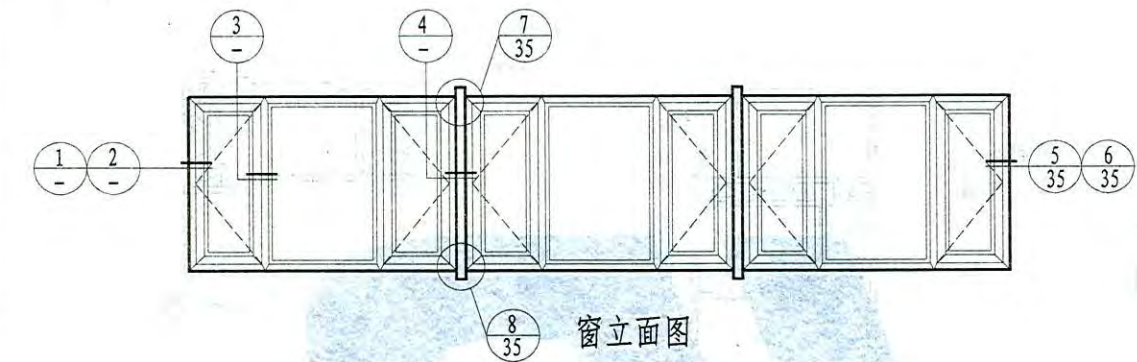

注：拼接窗的承接能力应经计算确定，具体组合形式及尺寸由设计人定。

A型-铝合金平开组合中空玻璃窗拼接安装节点图(一)		图集号	12YJ4-1
		页次	34

制	郝晓丹	郝晓丹
图	郝晓丹	郝晓丹
设计	郝晓丹	郝晓丹
校	刘鹰	刘鹰
核	张院洁	张院洁

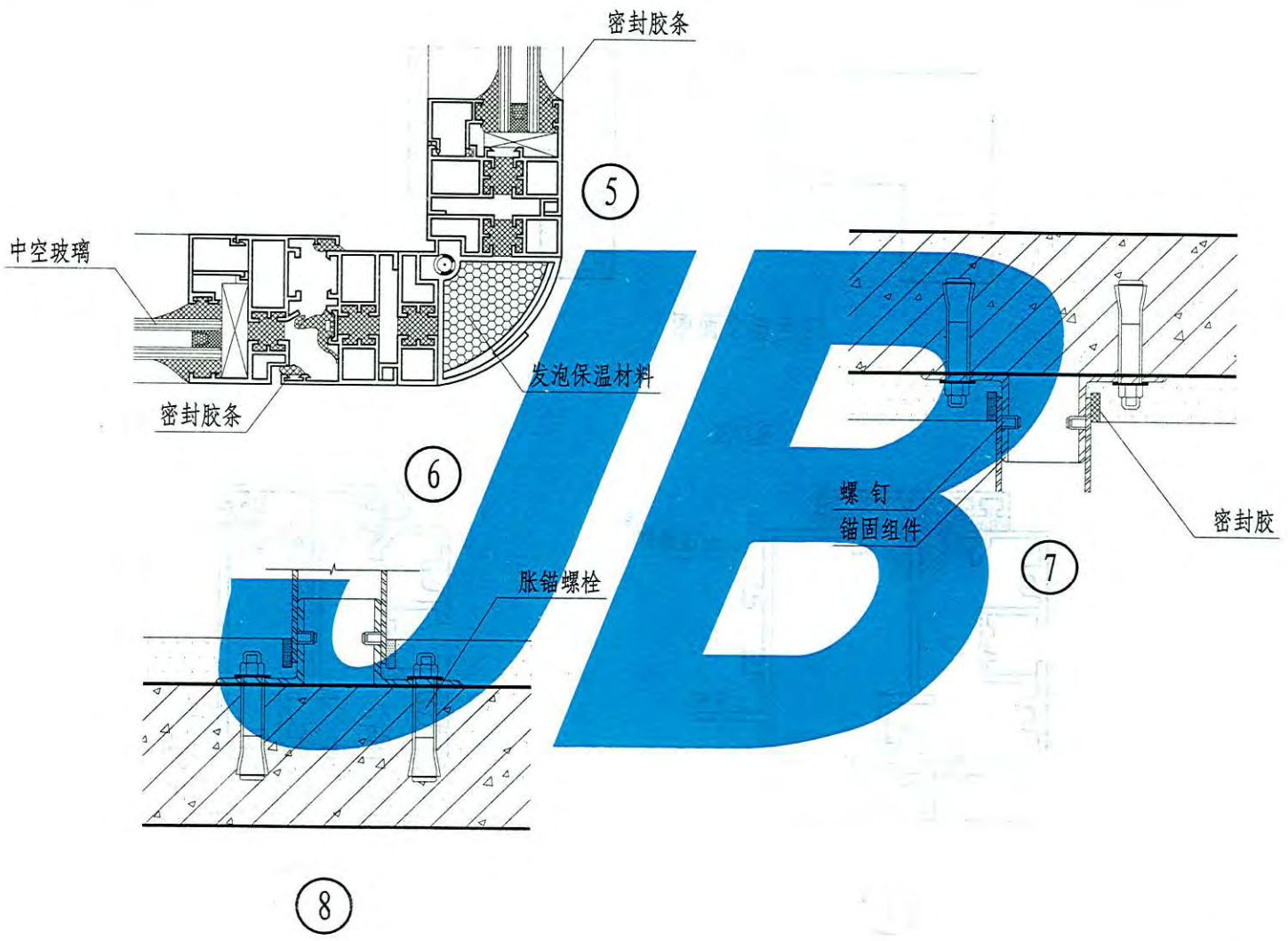

A型-铝合金平开组合中空玻璃窗拼接安装节点图(二)		图集号	12YJ4-1
		页次	35



制	图	郝晓丹	设计	郝晓丹	校	对	刘鹰凤	审	核	张	晓	洁
---	---	-----	----	-----	---	---	-----	---	---	---	---	---

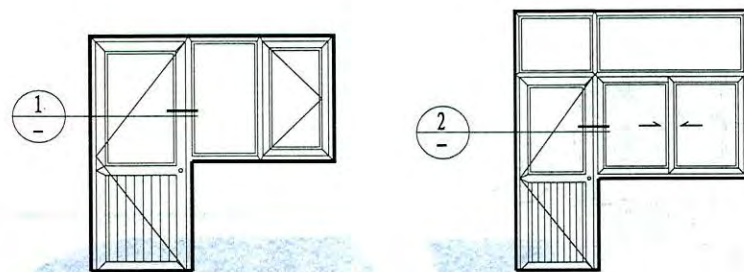

门连窗立面图

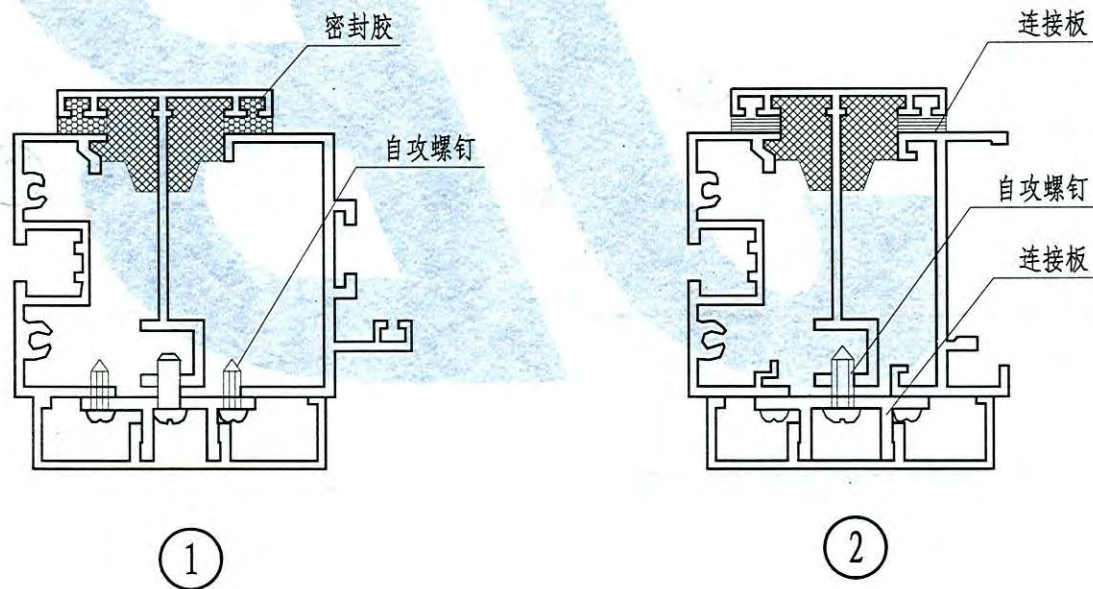

A型-铝合金单玻门连窗节点图	图集号	12YJ4-1
	页次	36

制图	郝晓丹
设计	郝晓丹
校对	郝晓丹
审核	刘鹰岚
设计	张晓洁

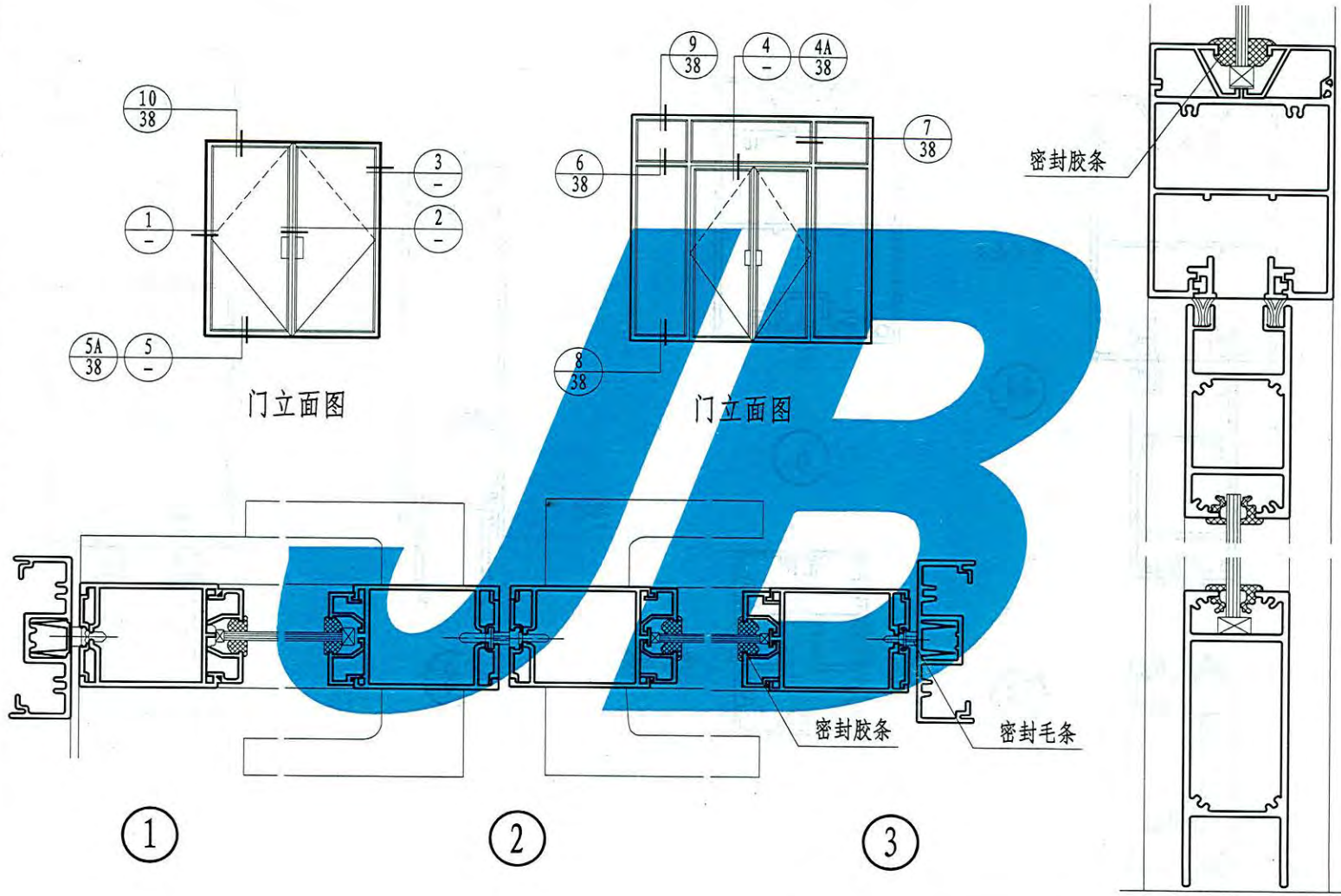

A型-铝合金地弹簧门 基本门节点图(一)	图集号	12YJ4-1
	页次	37

制图	郝晓丹
设计	郝晓丹
校对	郝晓丹
审核	刘鹰
张皓	张皓

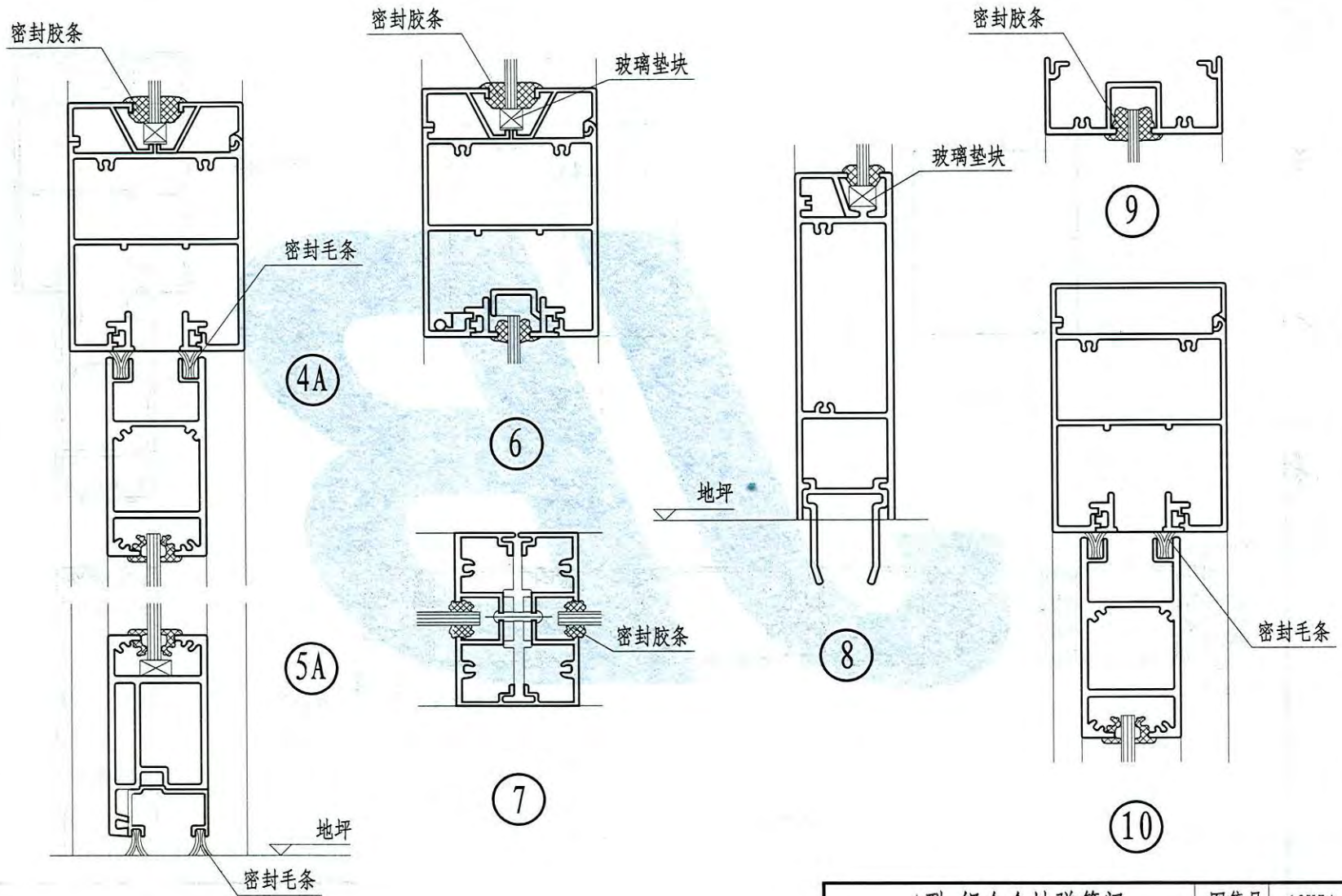

A型-铝合金地弹簧门  
基本门节点图(二)

制图 郝晓丹  
 设计 郝晓丹  
 校对 郝晓丹  
 审核 刘鹰  
 张亮  
 张亮

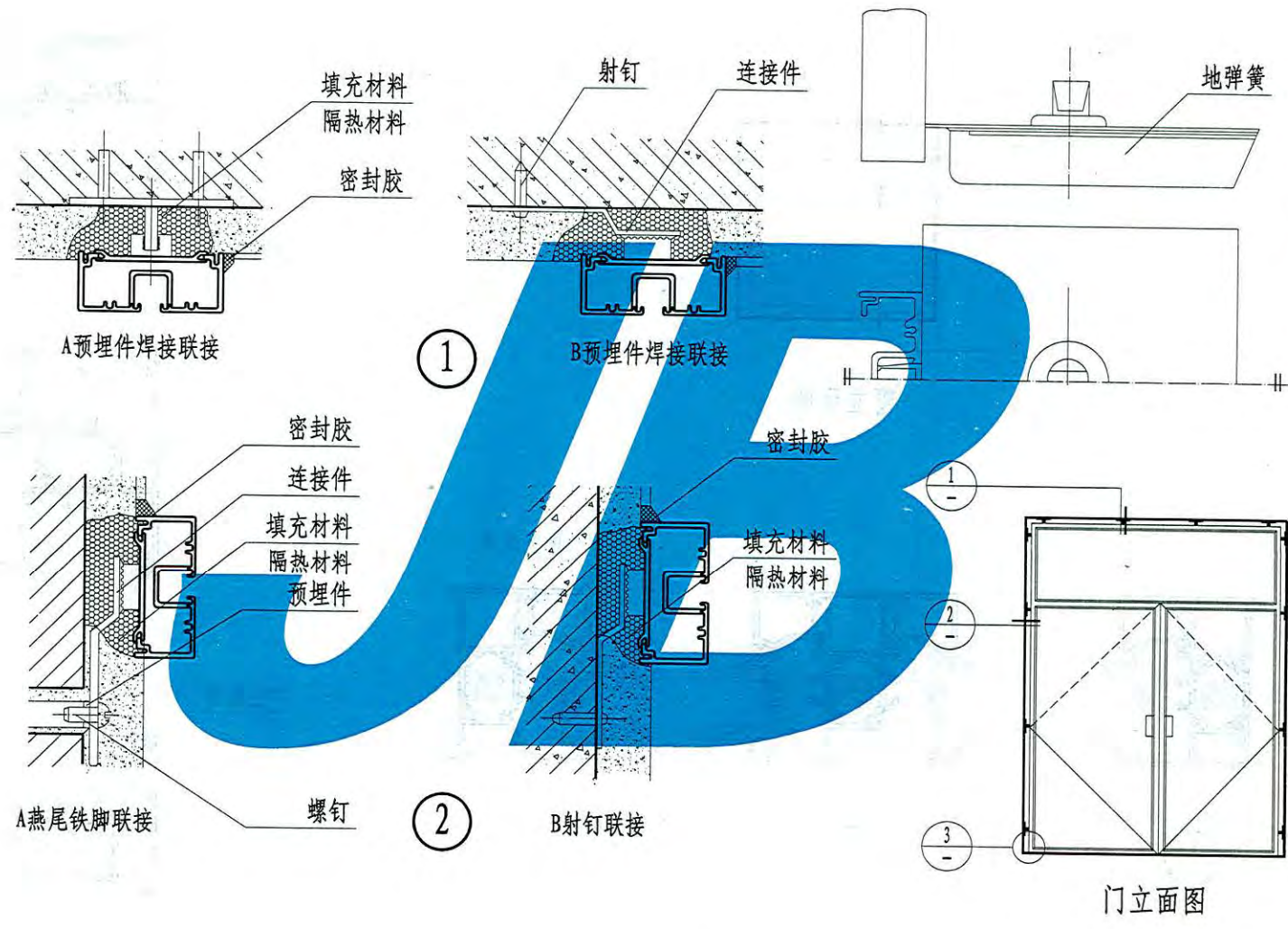

铝合金地弹簧门安装节点图		图集号	12YJ4-1
		页次	39

张 晓 洁  
核 审  
刘 鹰 凤  
对 校  
侯 红 霞  
计 设  
侯 红 霞  
制 图

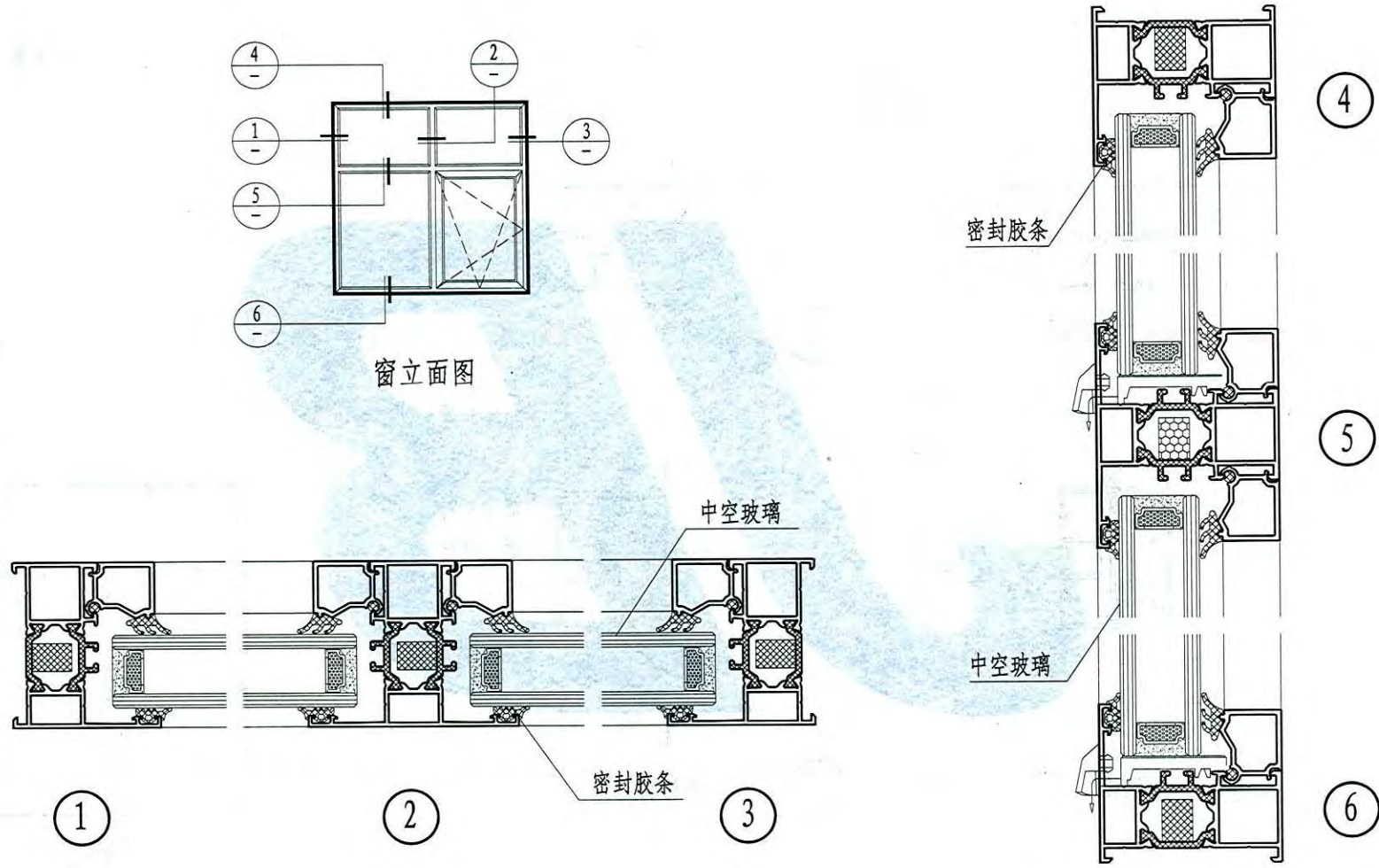

A型-铝合金内平开下悬窗		图集号	12YJ4-1
节点图(一)		页次	40

张 晓 洁  
核 审  
刘 鹰 凤  
校 对  
侯 红 霞  
设 计  
侯 红 霞  
制 图

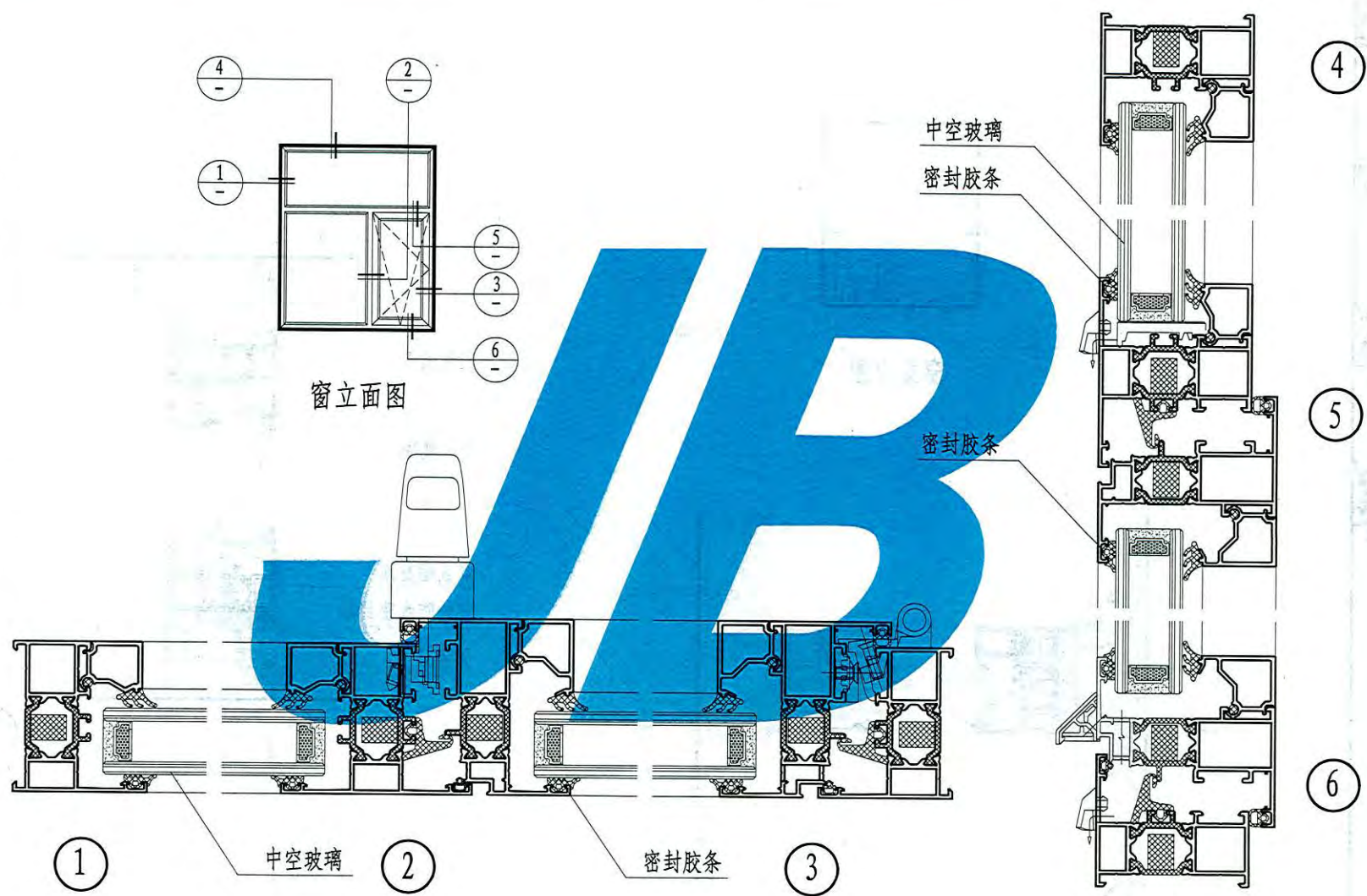

A型-铝合金内平开下悬窗		图集号	12YJ4-1
节点图(二)		页次	41

张 晓 洁  
核 对  
刘 鹰 岚  
校 对  
侯 红 霞  
设 计  
侯 红 霞  
制 图

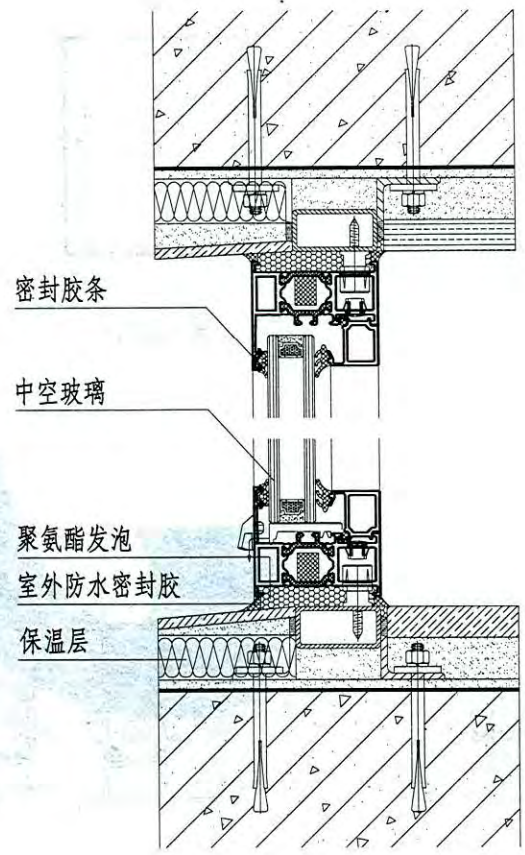
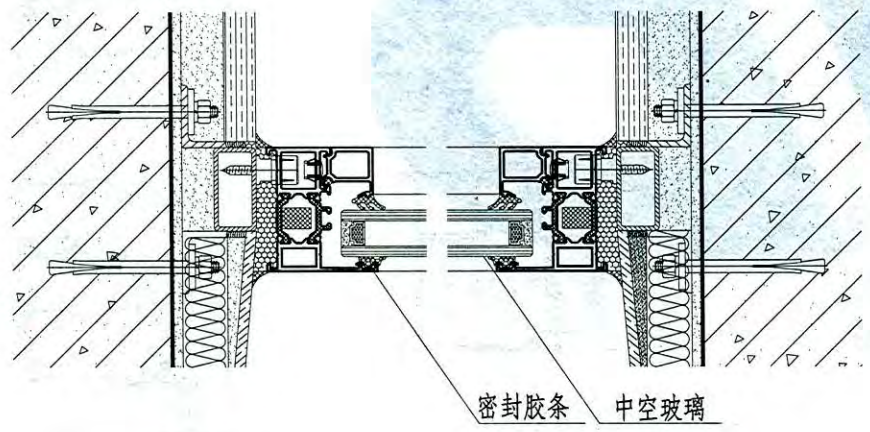
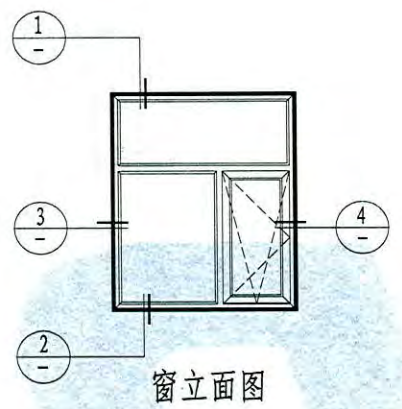

3

4

1

2

A型-铝合金内平开下悬窗 安装节点图(三)		图集号	12YJ4-1
		页次	42

张 晓 洁  
核 审  
刘 鹰 凤  
对 校  
郝 晓 丹  
设 计  
郝 晓 丹  
图 制

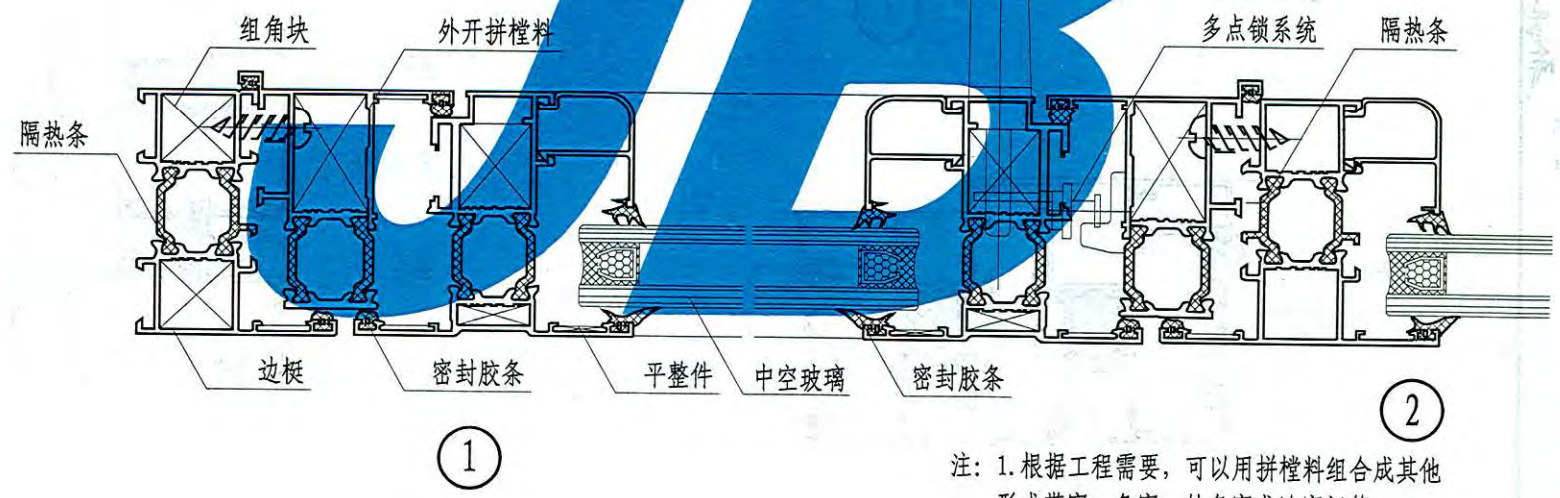
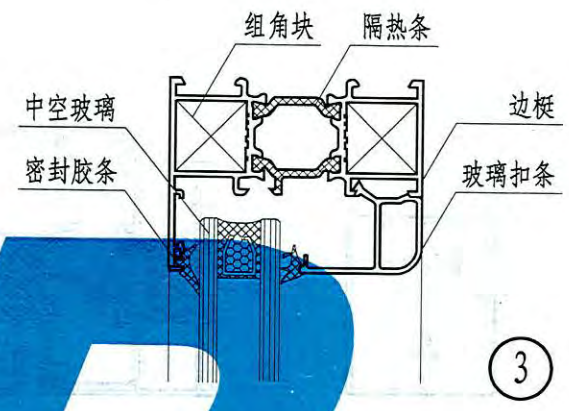
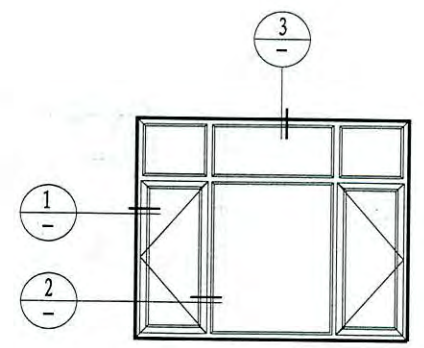

注：1. 根据工程需要，可以用拼樘料组合成其他形式带窗、条窗、转角窗或连窗门等。

A型-铝合金外平开窗节点图		图集号	12YJ4-1
		页次	43



制图 郝晓丹  
设计 郝晓丹  
校对 郝晓丹  
审核 刘鹰岚  
张晚洁

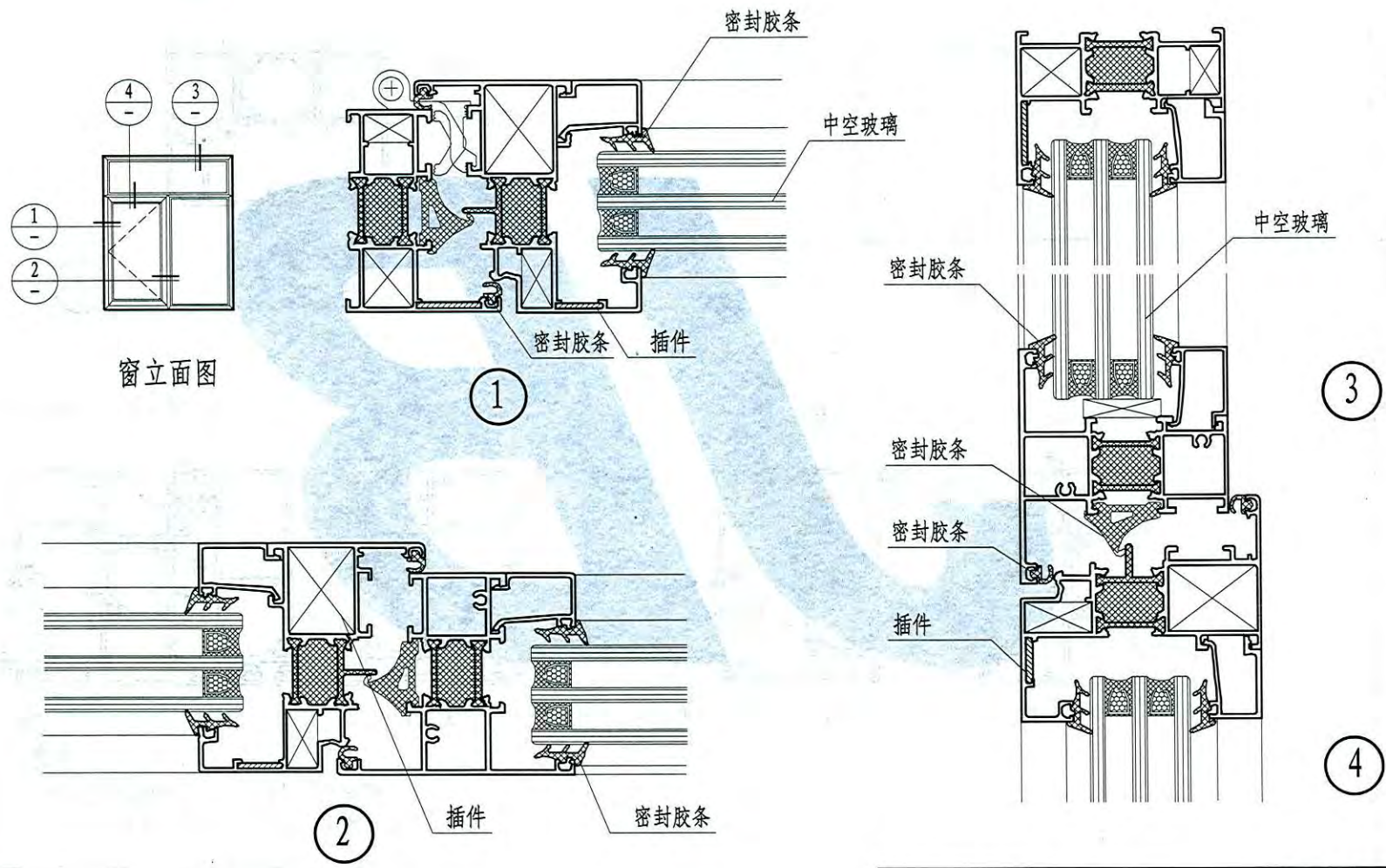

A型-铝合金内平开三玻窗节点图		图集号	12YJ4-1
		页次	44

张 晓 洁  
 核 审  
 刘 鹰 岚  
 对 校  
 郝 晓 丹  
 制 图

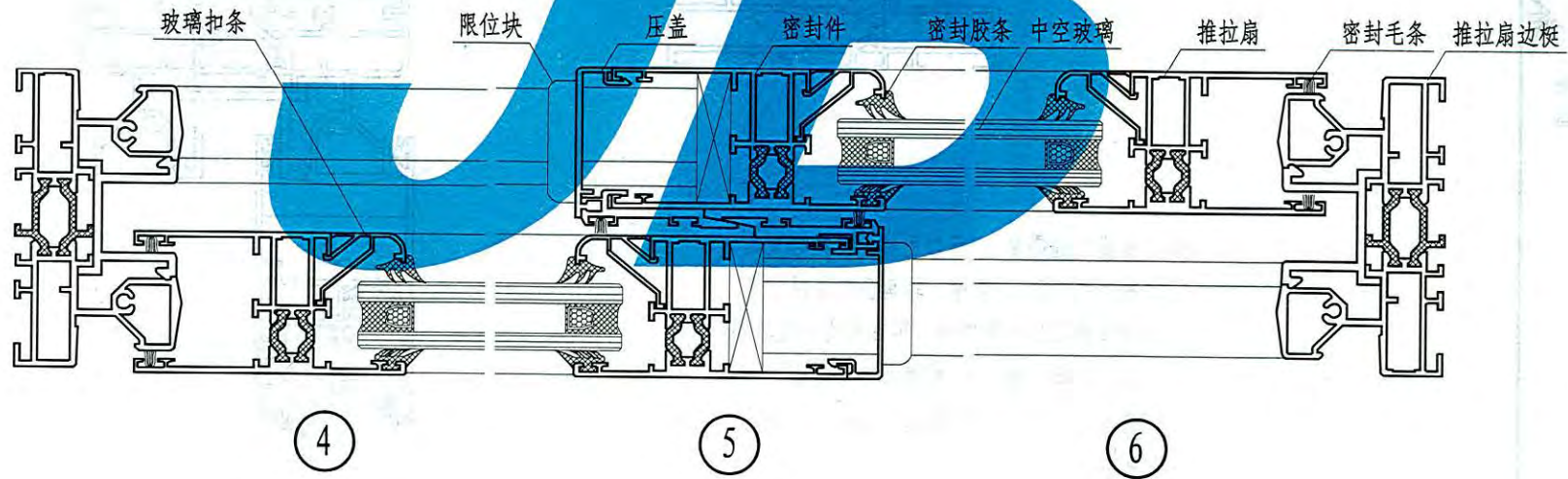
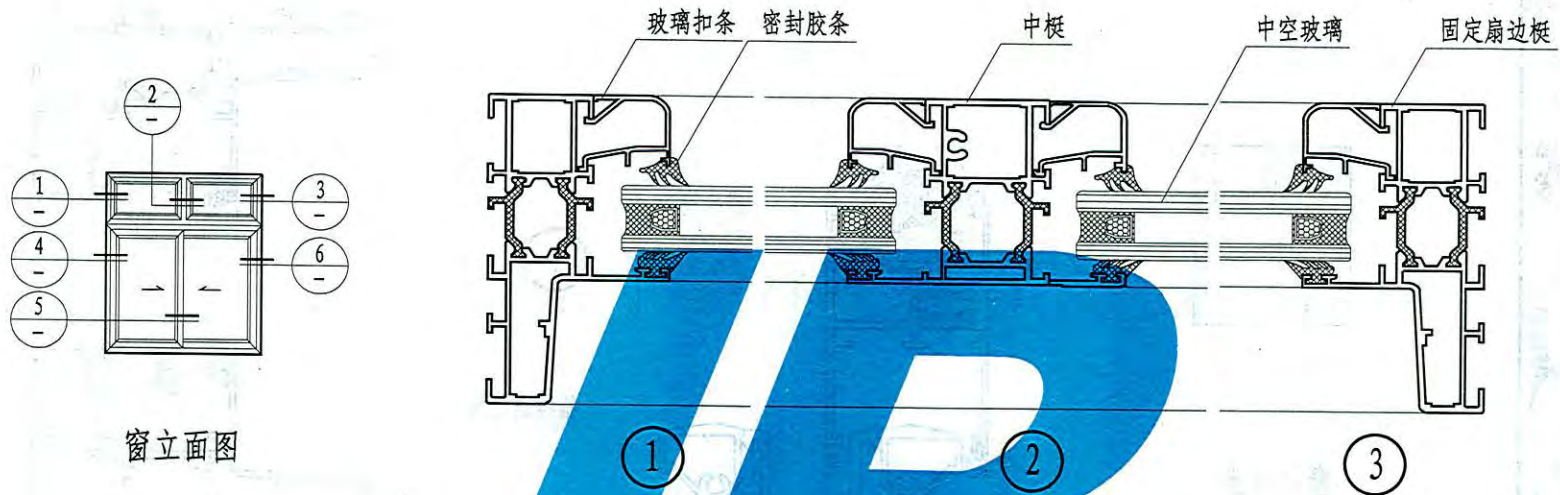

A型-铝合金推拉窗节点图(一)	图集号	12YJ4-1
	页次	45

张晓洁
核
刘鹰岚
校
郝晓丹
计
郝晓丹
制

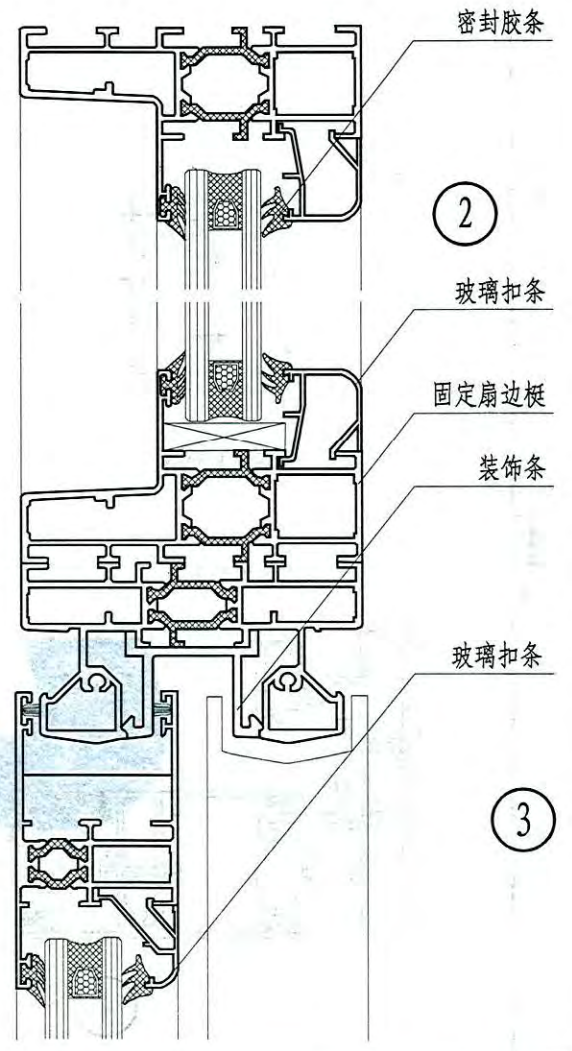
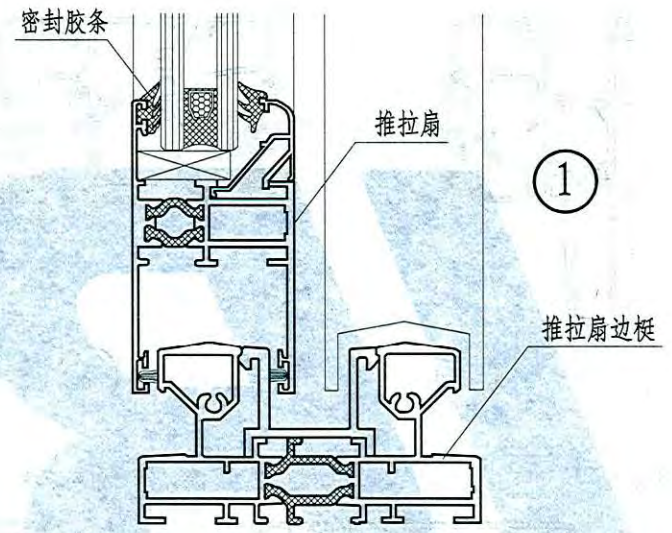

注:1.根据工程需要,可以用拼樘料组合成其他形式带窗、条窗、转角窗或连窗门等。  
 2.玻璃扣条位于室内侧,可在室内拆装玻璃,维修更换方便安全。玻璃扣条有方形、圆弧、斜角形等多边形式,取得不同的装饰效果。

张 晓 洁  
核 审  
刘 鹰 凤  
对 校  
郝 晓 丹  
计 设  
郝 晓 丹  
制 图

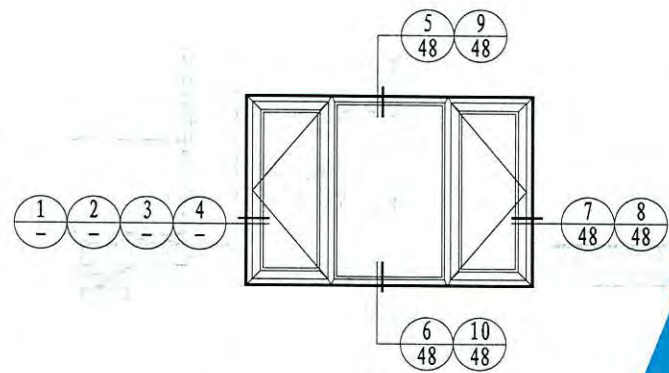

窗立面图

- 注: 1. 连接件尺寸  $\geq 140 \times 20 \times 1.5$   
 2. 焊接板尺寸  $\geq 140 \times 20 \times 1.5$   
 3. 金属膨胀螺栓  $\geq M6 \times 65$   
 塑料锚栓套管外径  $7 \sim 10 \text{ mm}$   
 4. 射钉  $\geq 3.7 \times 42$   
 5. 附框仅为示意, 具体详见工程设计

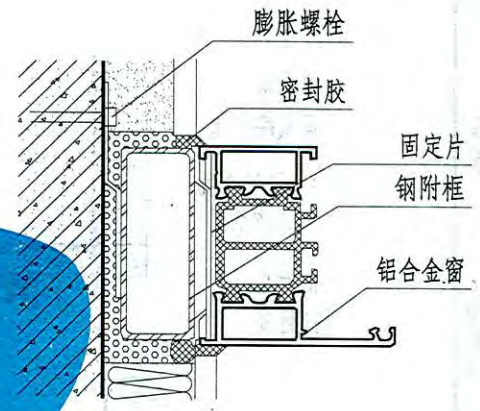

① 附框安装

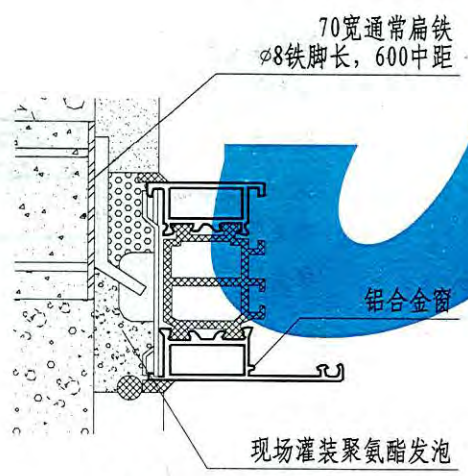

② 轻质墙体

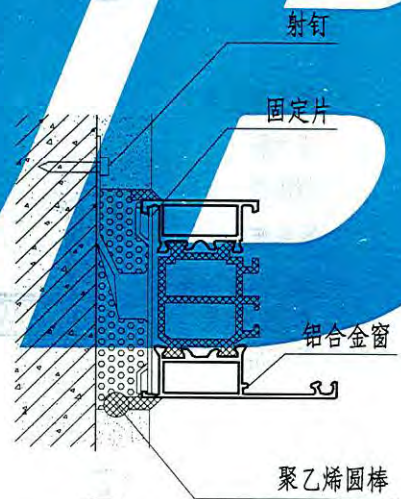

③ 钢筋混凝土墙体

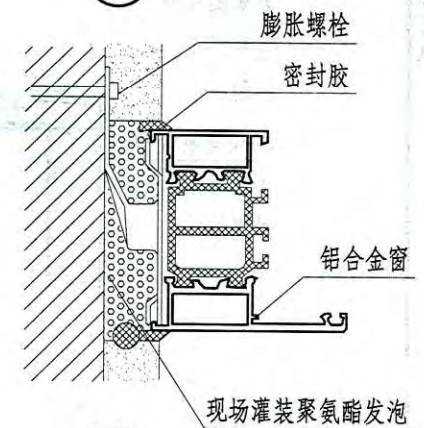

④ 砖墙体

铝合金门窗安装节点图

图集号	12YJ4-1
页次	47

张晚洁	张晚洁
核	
刘凤	刘凤
对	
郝晓丹	郝晓丹
计	
郝晓丹	郝晓丹
图	

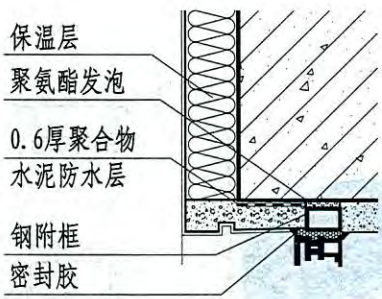

5

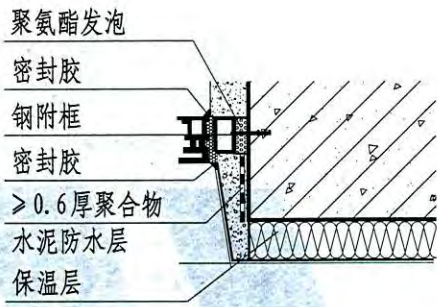

7

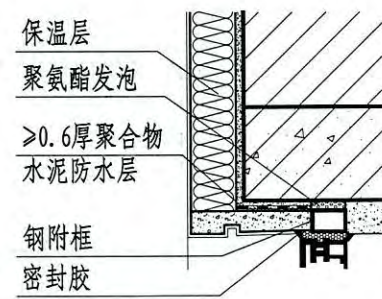

9

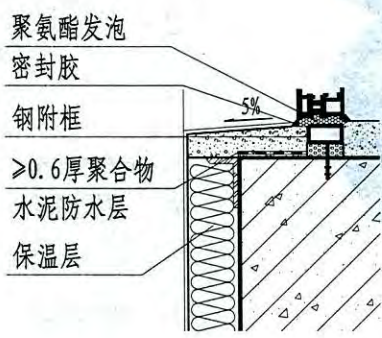

6

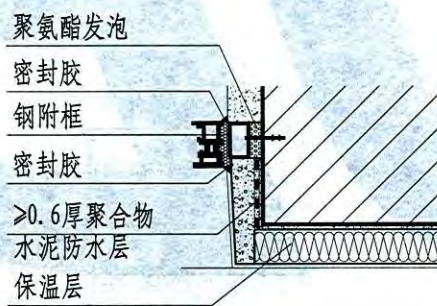

8

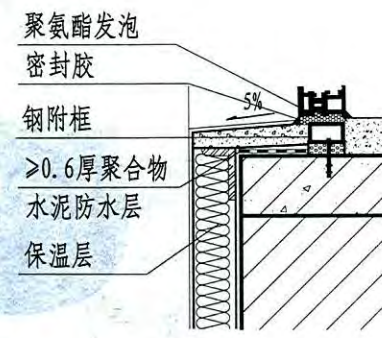

10

外门窗有附框安装节点图



制图 郝晓丹  
 设计 郝晓丹  
 校对 郝晓丹  
 审核 刘鹰凤  
 张晚洁

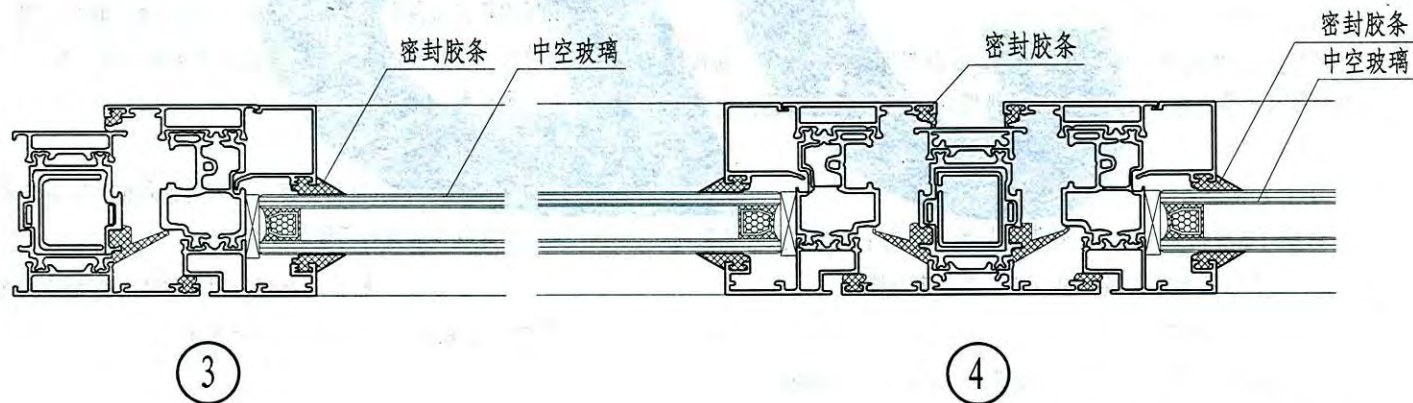
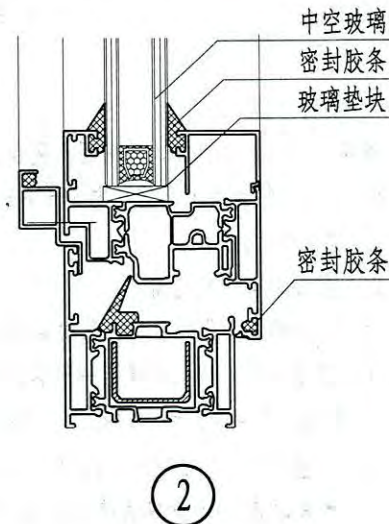
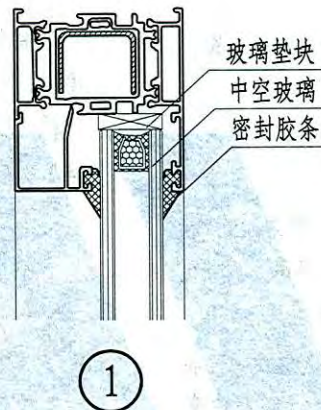
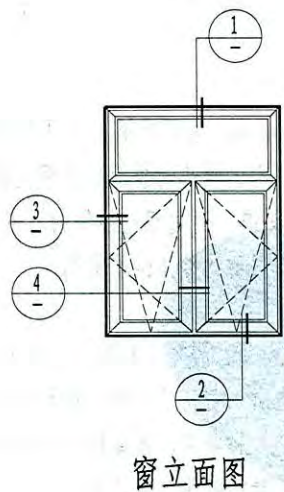

B型-内平开下悬 铝塑复合窗节点图		图集号 12YJ4-1
		页次 50

制图	郝晓丹	设计	郝晓丹	校对	郝晓丹	审核	刘鹰岚	审核	张婉洁
----	-----	----	-----	----	-----	----	-----	----	-----

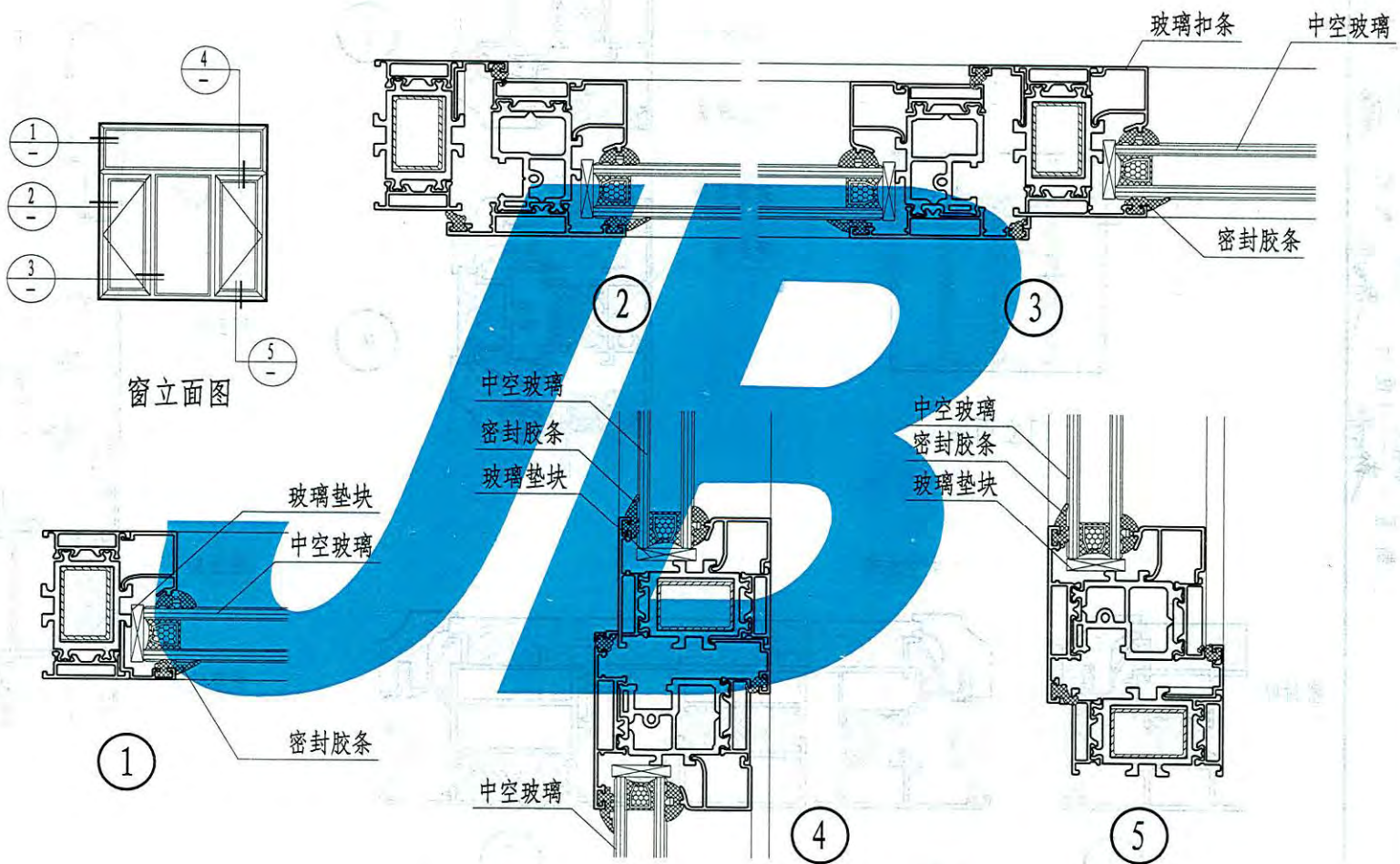

B型-外平开铝塑复合窗节点图	图集号	12YJ4-1
	页次	51



张 晓 洁  
 核 审  
 刘 鹰 凤  
 校 对  
 郝 晓 丹  
 计 设  
 郝 晓 丹  
 图 制

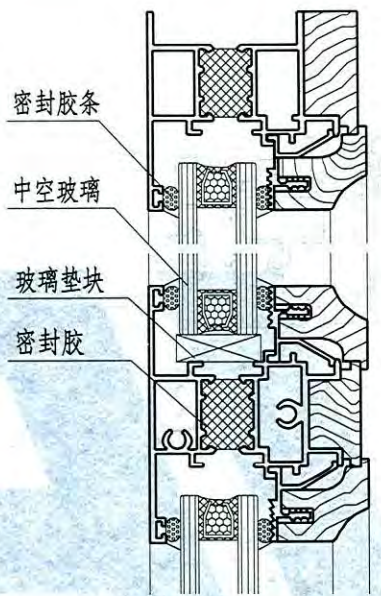
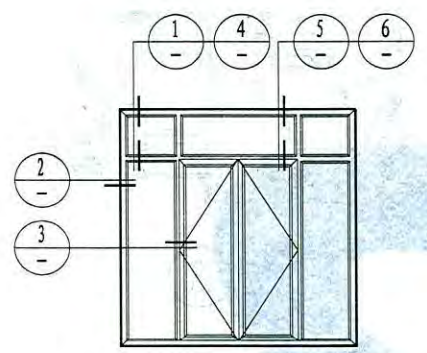

①

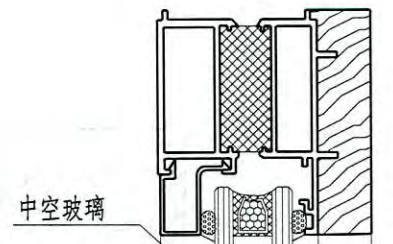

⑤

④

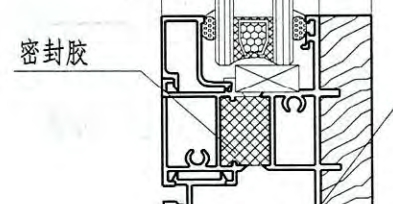

密封胶条

⑥

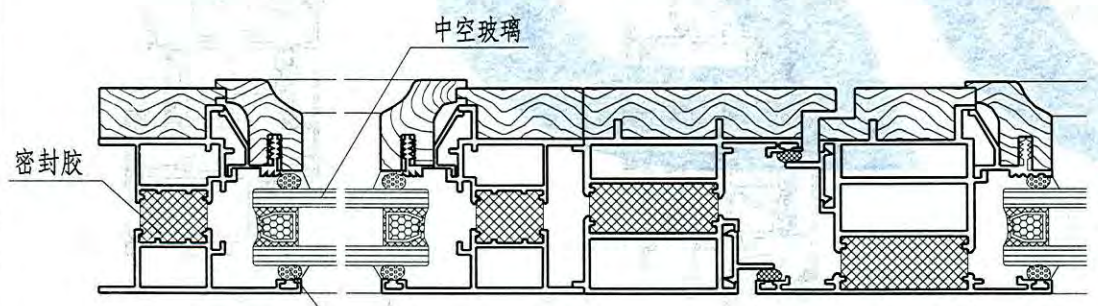

②

密封胶条

③

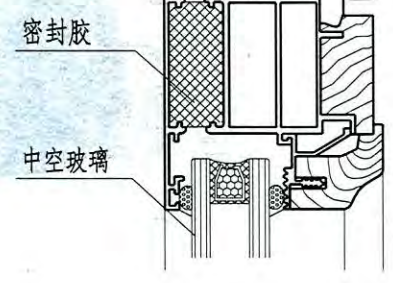

C型-木包铝外平开门节点图

图集号	12YJ4-1
页次	52

制图 郝晓丹  
 设计 郝晓丹  
 校对 郝晓丹  
 审核 刘鹰凤  
 张 晓 洁

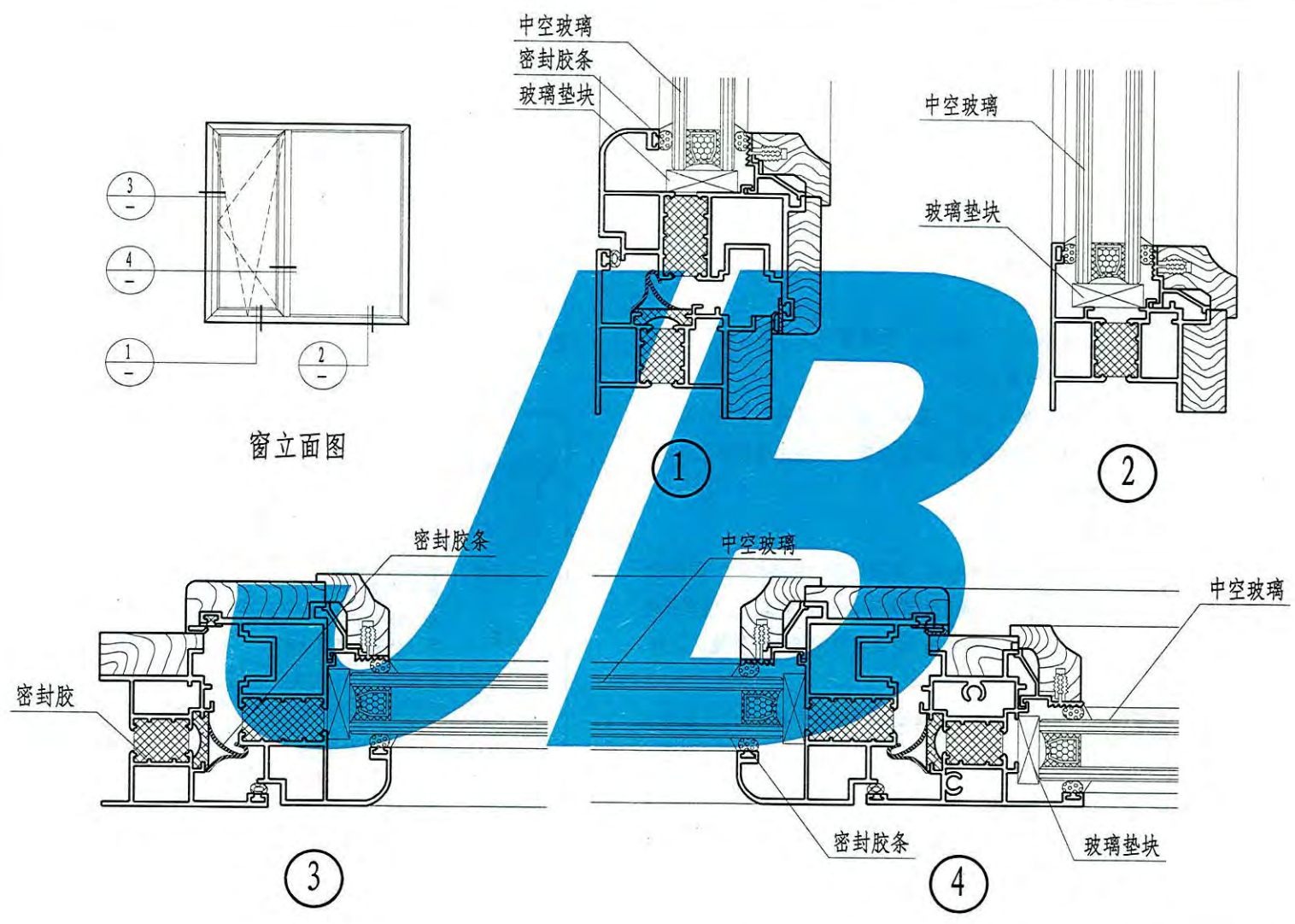

C型-木包铝平开下悬窗节点图

图集号	12YJ4-1
页次	53

张 晓 洁  
核 审  
侯 红 霞  
对 校  
刘 鹰 岚  
计 设  
曹 越  
图 制

## D型-塑料门窗说明

### 1. 编制依据

《未增塑聚氯乙烯 (PVC-U) 塑料门》 (JG/T 180-2005)

《未增塑聚氯乙烯 (PVC-U) 塑料窗》 (JG/T 140-2005)

《塑料门窗工程技术规程》 (JGJ 103-2008)

### 2. 编制内容

2.1 内平开门、外平开门、推拉门、地弹簧门、外平开窗、内平开下悬窗、推拉窗的构造节点示意图。

2.2 组合门窗拼接安装节点图、基本门窗通用安装节点图。

2.3 本图集节点图以中空玻璃、单层玻璃、三层玻璃表示, 具体选用可根据工程需要确定。

### 3. 适用范围及特点

3.1 适用范围: 塑料门窗具有美观、密闭性强、保温性好、耐腐蚀等优点。尤其适用于沿海地区、潮湿房间及寒冷和严寒地区。但其线性膨胀系数较大, 在大洞口外窗中使用时, 应采用分樘组合等措施, 以防止变形。

3.2 技术特点: 塑料门窗主要指用未增塑聚氯乙烯 (PVC) 树脂为为主要原料, 按比例加入光稳定剂、热稳定剂、抗冲击改性剂、填充剂等多种助剂, 通过机械混合塑化、挤出、成型为各种不同断面结构的型材、杆件。通过对型材切割, 穿入增强型钢, 焊接后装上五金件、密封胶条、毛条及玻璃等成为成品门窗。塑料门窗采用密封条、紧固件、五金配件等应符合国家现行标准的有关规定。

为增加窗的刚性, 在窗框、窗扇、窗框型材的受力杆件中, 根据抗

风压强度的设计和其他使用要求, 确定窗型材内增强型钢的类型, 增强型钢应与型材内腔紧密吻合。

### 4. 技术要求

塑料门窗的力学性能应符合《未增塑聚氯乙烯 (PVC-U) 塑料门》JG/T180、《未增塑聚氯乙烯 (PVC-U) 塑料窗》JG/T140的要求, 具体见表4-1~表4-4。

表 4-1 平开窗、上悬窗、中悬窗、下悬窗的力学性能

项目	技术要求
锁紧器(执手)的开关力	不大于80N(力矩不大于10N·m)
开关力	平铰链不大于80N, 滑撑铰链不小于30N、不大于80N
悬端吊重	在500N力作用下, 残余变形不大于2mm, 试件不损坏, 仍保持使用功能
翘曲	在300N力作用下, 允许有不影响使用的残余变形, 试件不损坏, 仍保持使用功能
开关疲劳	经过不少于10000次的开关试验, 试件及五金件不损坏, 其固定处及玻璃压条等不松脱, 仍保持使用功能
大力关闭	经模拟7级风开关10次, 试件不损坏, 仍保持开关功能
焊接角破坏力	窗框不低于2000N, 窗扇不低于2500N
窗撑试验	在200N力作用下, 不允许位移, 连接处型材不破裂
开启限位装置(制动器)受力	在10N力作用下, 开启10次, 试件不损坏
注: 大力关闭只检测平开窗和上悬窗	

D型-塑料门窗说明(一)

图集号 12YJ4-1

页次 54

张晚洁  
核  
侯红霞  
对  
刘鹰凤  
计  
曹曹  
图

表 4-2 推拉窗的力学性能

项目	技术要求
开关力	不大于100N
弯曲	在300N力作用下, 允许有不影响使用的残余变形, 试件不损坏, 仍保持使用功能
扭曲	在200N力作用下, 试件不损坏, 允许有不影响使用的残余变形
开关疲劳	经过不少于10000次的开关试验, 试件及五金件不损坏, 其固定处及玻璃压条等不松脱
焊接角破坏力	窗框不低于2500N, 窗扇不低于1400N

注: 无凸出把手的推拉窗不做扭曲试验。

表 4-3 平开门、地弹簧门的力学性能

项目	技术要求
锁紧器(执手)开关力	不大于100N(力矩不大于10N·m)
开关力	不大于80N
悬端吊重	在500N力作用下, 残余变形不大于2mm, 试件不损坏, 仍保持使用功能
翘曲	在300N力作用下, 允许有不影响使用的残余变形, 试件不损坏, 仍保持使用功能
开关疲劳	经过不少于100000次的开关试验, 试件及五金件不损坏, 其固定处及玻璃压条不松脱, 仍保持使用功能
大力关闭	经模拟7级风连续开关10次, 试件不损坏, 仍保持开关功能
垂直荷载强度	对门扇施加30kg荷载, 门扇卸荷后的下垂量不应大于2mm
焊接角破坏力	门框不低于3000N, 门扇不低于6000N
软物冲击	无破损, 开关功能正常
硬物冲击	无破损

注: 全玻璃门不检测软、硬物体的撞击性能。

表 4-4 推拉门的力学性能

项目	技术要求
开关力	不大于100N
弯曲	在300N力作用下, 允许有不影响使用的残余变形, 试件不损坏, 仍保持使用功能
扭曲	在200N力作用下, 允许有不影响使用的残余变形, 试件不损坏
开关疲劳	经过不少于100000次的开关试验, 试件及五金配件不损坏, 其固定处及玻璃压条不松脱
软物冲击	试验后无损坏, 启闭功能正常
硬物冲击	试验后无破损
焊接角破坏力	门框不低于3000N, 门扇不低于4000N

注: 1. 无凸出把手的推拉门不做扭曲试验。  
2. 全玻璃门不检测软、硬物的撞击性能。

5. 安装施工

5.1 门窗安装质量要求应符合《塑料门窗工程技术规程》JGJ103的规定, 具体见表5-1、表5-2。

表 5-1 洞口宽度或高度尺寸的允许偏差 (mm)

洞口类型		洞口宽度或高度		
		<2400	2400~4800	>4800
不带附框洞口	未粉刷墙面	±10	±15	±20
	已粉刷墙面	±5	±10	±15
已安装附框的洞口		±5	±10	±15

D型-塑料门窗说明(二)

图集号 12YJ4-1  
页次 55

张晚洁	张晚洁
核	
审	
侯红霞	侯红霞
对	
校	
刘凤	刘凤
计	
设	
曹越	曹越
图	
制	

表 5-2 门窗的安装允许偏差

项 目	允许偏差 (mm)	检验方法
门、窗框外形 (高、宽) 尺寸长度差	≤1500mm	2 用精度1mm钢卷尺, 测量外框两相
	>1500mm	3 对外端面, 测量部位距端部100mm
门、窗框两对角线长度差	≤2000mm	3 用精度1mm钢卷尺, 测量内角
	>2000mm	5
门、窗框 (含拼樘料) 正、侧面垂直度	3	用1m垂直检测尺检查
门、窗框 (含拼樘料) 水平度	3.0	用1m水平尺和精度0.5mm塞尺检查
门、窗下横框的标高	5	用精度1mm钢直尺检查, 与基准线比较
双层门、窗内外框间距	4.0	用精度0.5mm钢直尺检查
门、窗竖向偏离中心	5.0	用精度0.5mm钢直尺检查
平开门窗及上悬、下悬、中悬窗	门、窗扇与框搭接量	2.0 用深度尺或精度0.5mm钢直尺检查
	同樘门、窗相邻扇的水平高度差	2.0 用靠尺或精度0.5mm钢直尺检查
	门、窗框扇四周的配合间隙	1.0 用楔形塞尺检查
推拉门窗	门、窗扇与框搭接量	2.0 用深度尺或精度0.5mm钢直尺检查
	门、窗扇与框或相邻扇立边平行度	2.0 用精度0.5mm钢直尺检查
组合门窗	平面度	2.5 用2m靠尺和精度0.5mm钢直尺检查
	竖缝直线度	2.5 用2m靠尺和精度0.5mm钢直尺检查
	横缝直线度	2.5 用2m靠尺和精度0.5mm钢直尺检查

## 5.2 门窗框安装要点

5.2.1 轻质砌块墙上的门垛或大洞口的窗垛应采取加强措施, 如做钢筋混凝土抱框。

5.2.2 有外保温或外饰面材料较厚时, 外窗宜采用增加钢附框的安装方式。钢附框应采用壁厚不小于1.5mm的碳素结构钢或低合金结构钢制成, 附框内、外表面均应进行防锈处理。

### 5.2.3 门窗框上固定片的固定方法:

1) 混凝土墙洞口应采用射钉或膨胀螺钉固定。

2) 实心砖墙洞口应采用膨胀螺钉固定, 不得固定在砖缝处。严禁采用射钉固定。

3) 轻质砌块, 空心砖或加气混凝土材料洞口可在预埋混凝土块上用射钉或膨胀螺钉固定。

4) 设有预埋件的洞口应采用焊接方法固定, 也可先在预埋件上按紧固件规格打基孔, 然后用紧固件固定。

5.2.4 窗框与洞口之间的伸缩缝内应采用聚氨酯发泡胶填充, 发泡胶填充应均匀、密实。对于保温、隔声等级要求较高的工程, 应先按设计要求采用相应的隔热、隔声材料填塞, 然后再采用聚氨酯发泡胶封堵。

5.2.5 有外遮阳时, 应考虑外遮阳设施与窗框之间的关系。

5.2.6 安装节点构造见本图集节点安装图。

## 6. 施工、验收、检验

塑料门窗工程的施工、验收、检验应按现行国家标准《建筑工程施工质量验收统一标准》GB50300及《建筑装饰装修工程质量验收规范》GB 50210的有关规定执行。

制图	王玉珏 王玉珏
设计	王玉珏 王玉珏
校对	刘鹰岚 刘鹰岚
审核	张晓洁 张晓洁

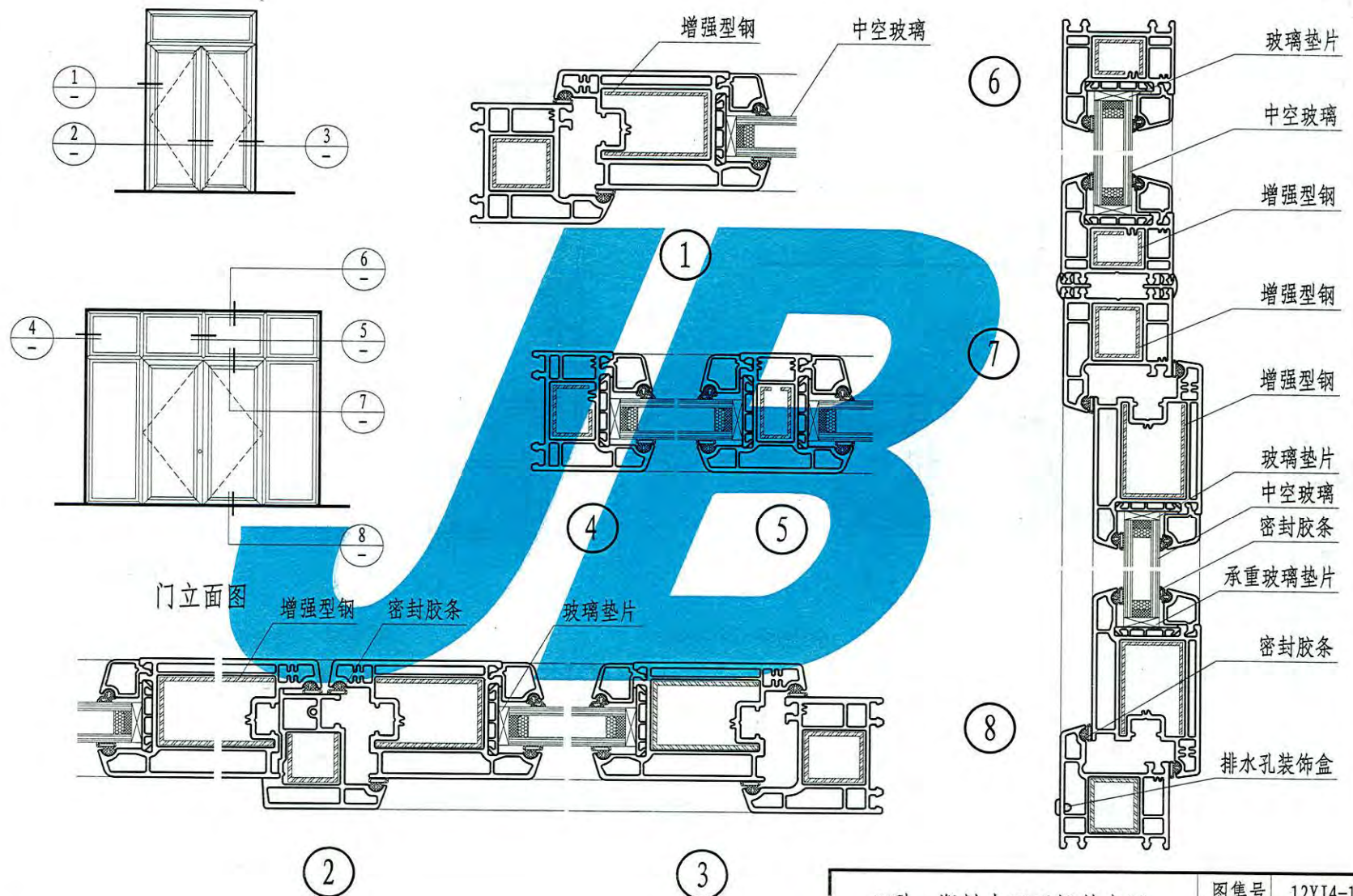

D型—塑料内平开门节点图	图集号	12YJ4-1
	页次	57

制图 王玉珏 王玉珏  
设计 王玉珏 王玉珏  
校对 刘鹰岚 刘鹰岚  
审核 张晚洁 张晚洁

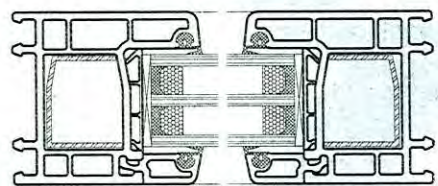
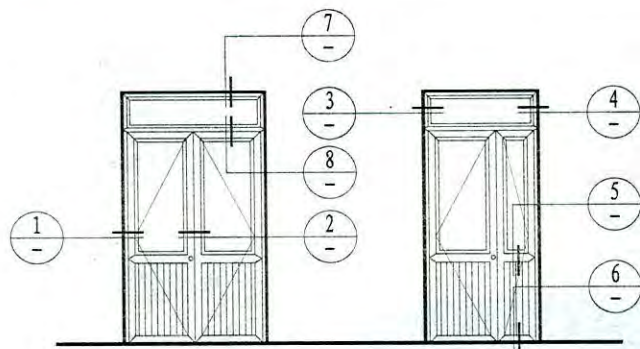

3

4

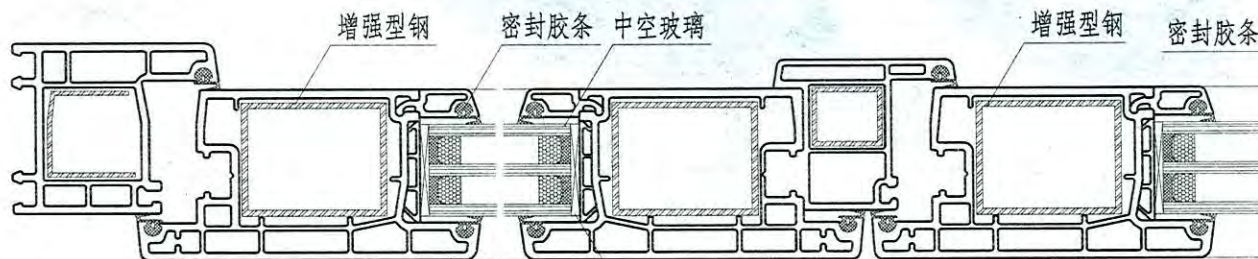

1

2

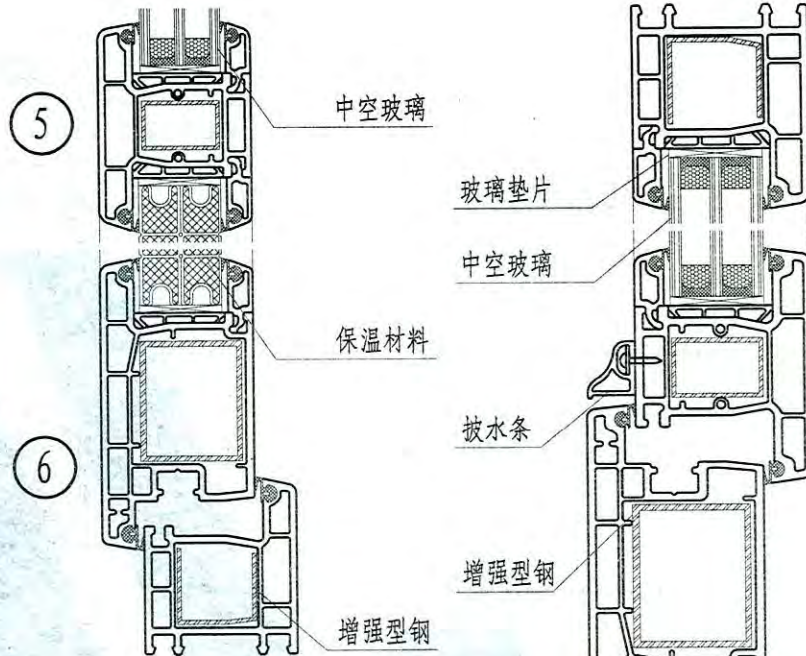

5

6

中空玻璃

玻璃垫片

中空玻璃

保温材料

披水条

增强型钢

增强型钢

密封胶条

密封胶条

7

8

D型—塑料外平开门节点图  
(带门芯板)

图集号	12YJ4-1
页次	58

制	王玉班	王玉班
图	王玉班	王玉班
设计	王玉班	王玉班
校	刘鹰凤	刘鹰凤
审	核	核
张	晓洁	张

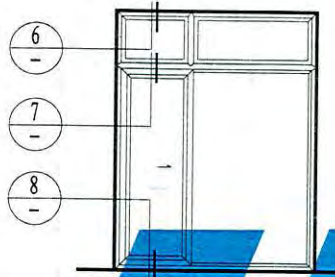
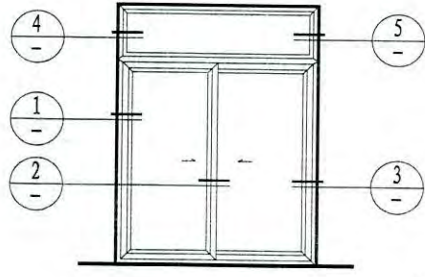

门立面图

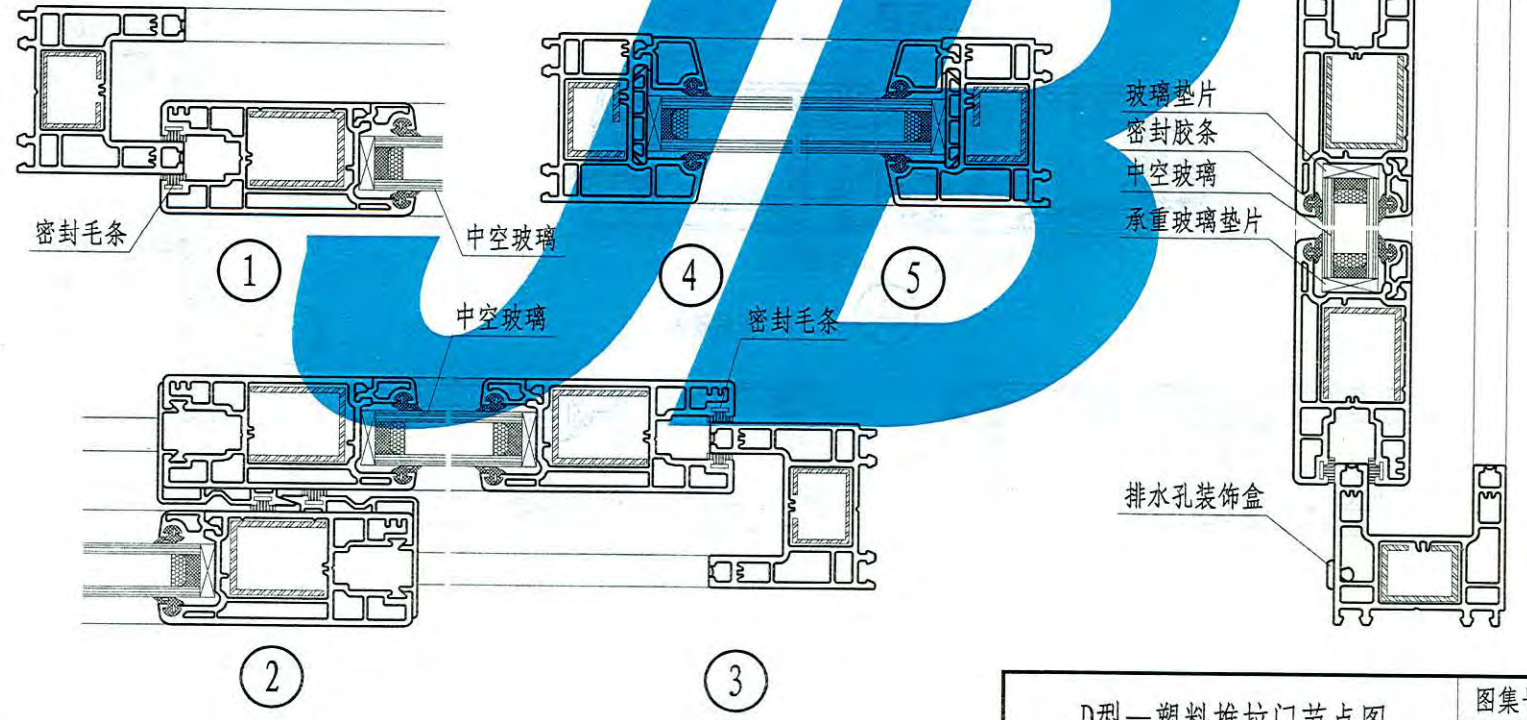

D型—塑料推拉门节点图

图集号	12YJ4-1
页次	59



张 晓 洁  
 刘 鹰 岚  
 刘 燕  
 刘 燕

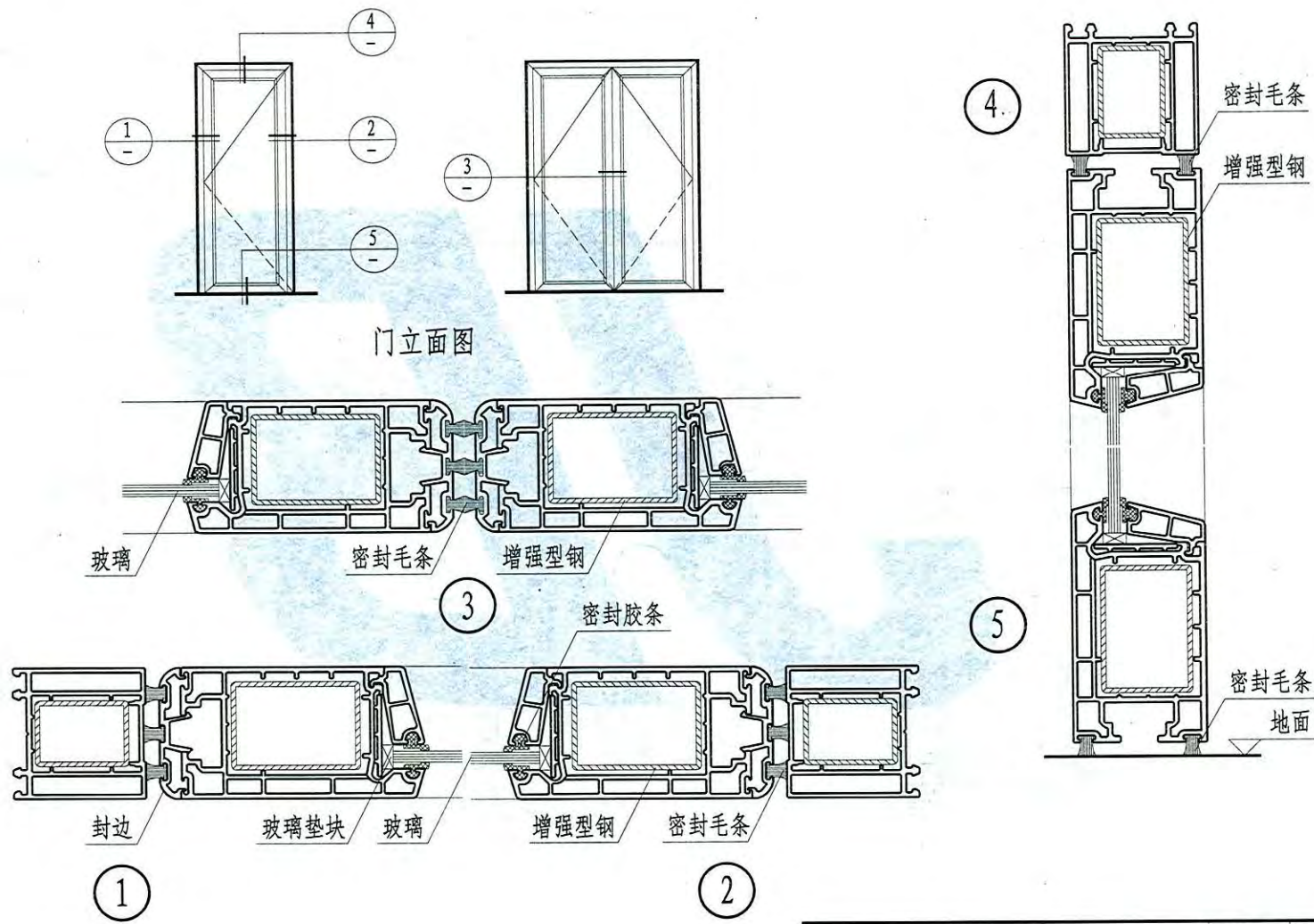

D型—塑料地弹簧门节点图

制	王玉珏	王玉珏
图	王玉珏	王玉珏
设计		
校	王玉珏	王玉珏
对		
校	刘腾岚	刘腾岚
审		
核		
张	张	张
晓	晓	晓
洁	洁	洁

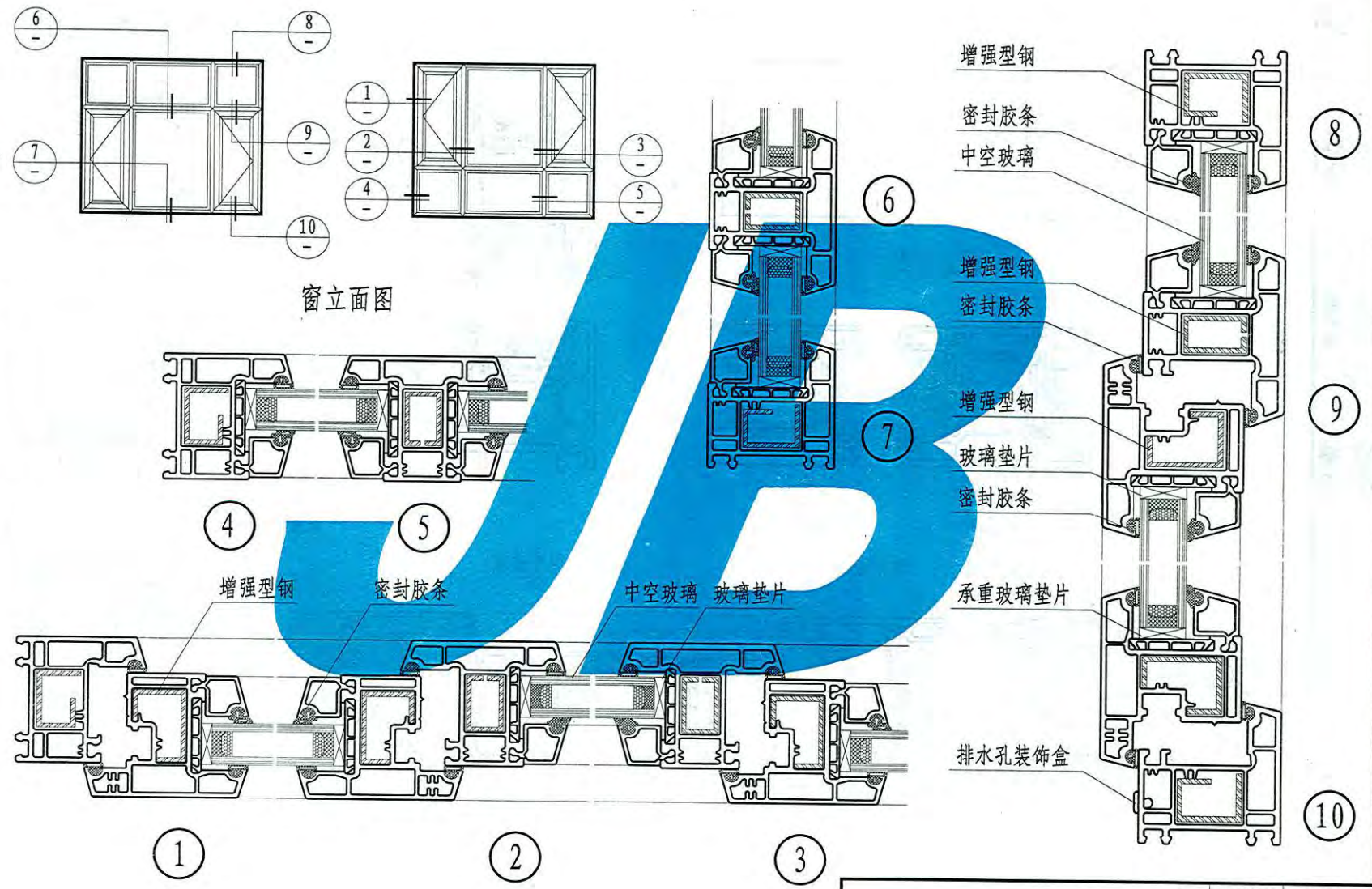

D型—塑料外平开窗节点图	图集号	12YJ4-1
	页次	61

制 图 王 玉 珏  
 设 计 王 玉 珏  
 校 对 刘 鹰 凤  
 审 核 张 晓 洁  
 张 晓 洁  
 王 玉 珏

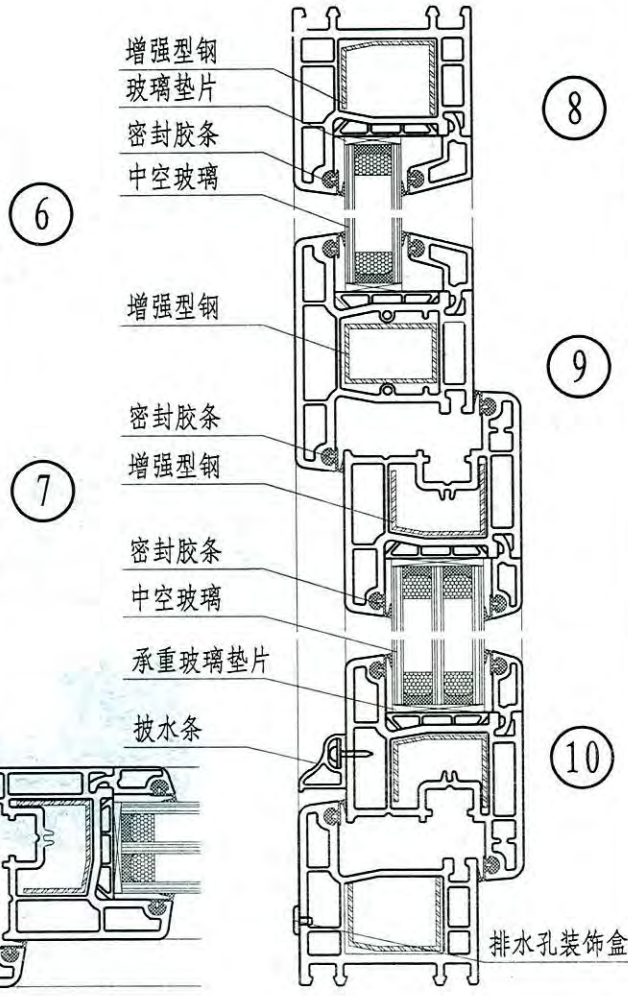
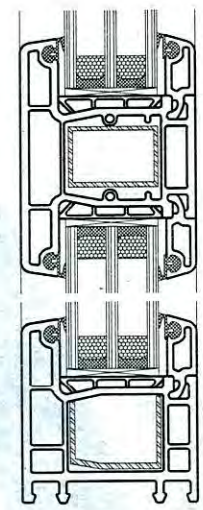
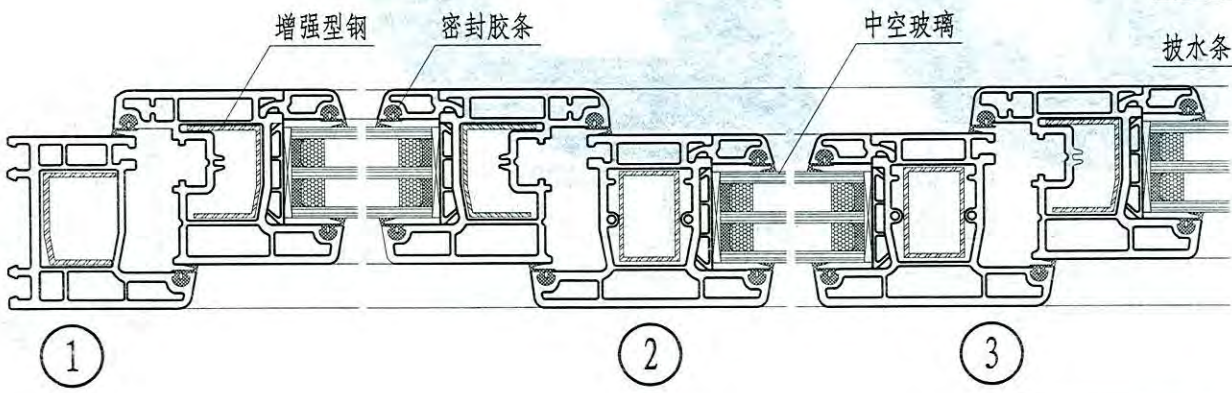
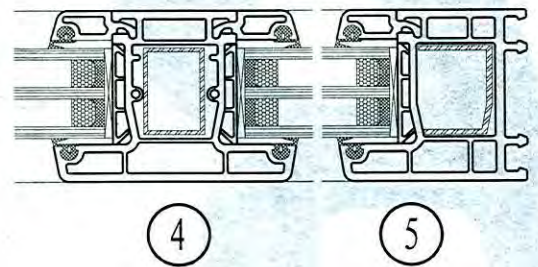
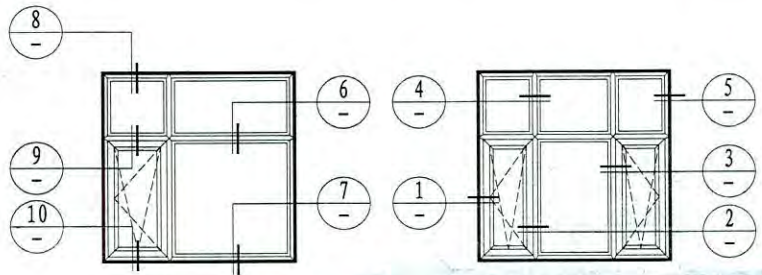

D型—塑料内平开下悬窗节点图

图集号	12YJ4-1
页次	62

制图 王玉珏 王玉珏  
 设计 王玉珏 王玉珏  
 校对 王玉珏  
 审核 刘鹰岚  
 张晚洁

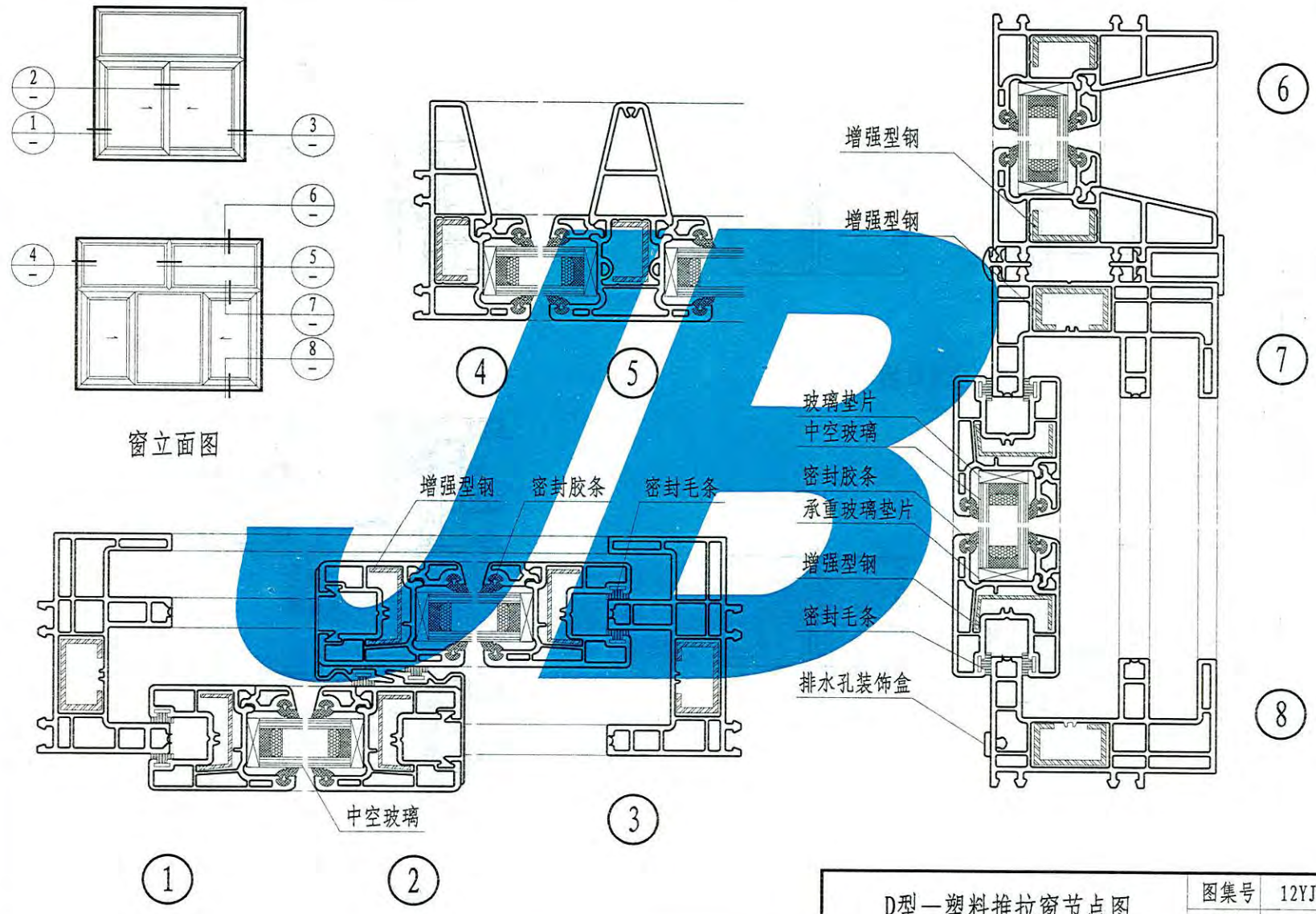

D型—塑料推拉窗节点图

图集号	12YJ4-1
页次	63

制图	王玉珏 王玉珏
设计	王玉珏 王玉珏
校对	刘鹰岚 刘鹰岚
审核	张晓洁 张晓洁

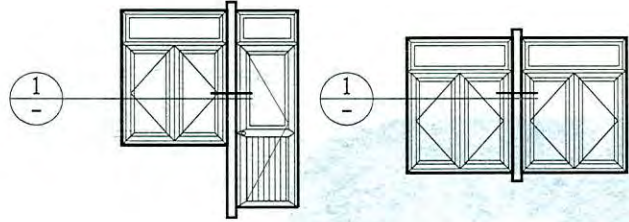

窗立面图

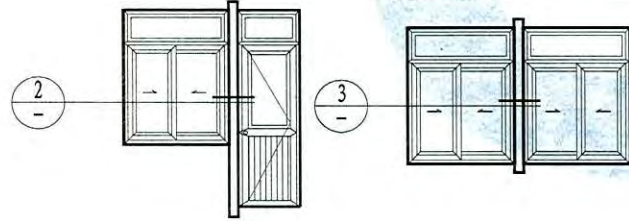

窗立面图

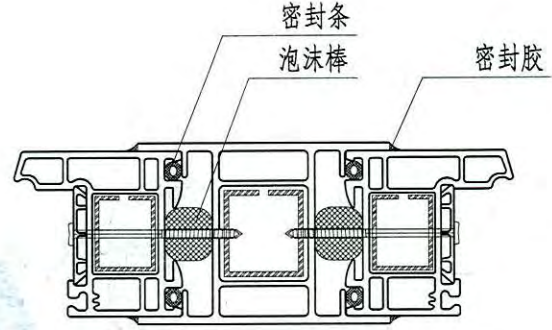

1

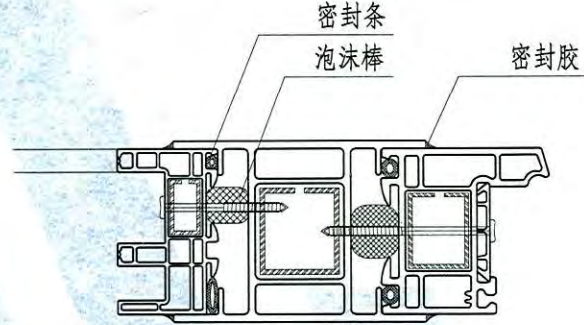

2

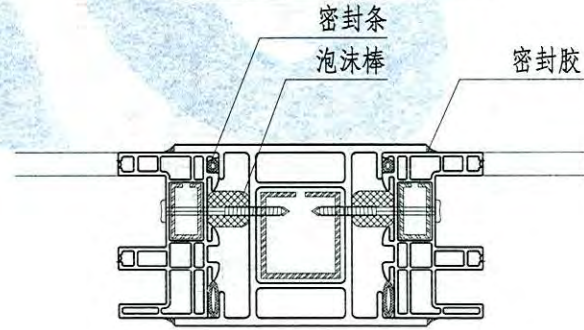

3

D型—塑料组合门窗拼接节点图

图集号	12YJ4-1
页次	64

制图	王玉珏 王玉珏
设计	王玉珏 王玉珏
校对	刘鹰岚 刘鹰岚
审核	张晓洁 张晓洁

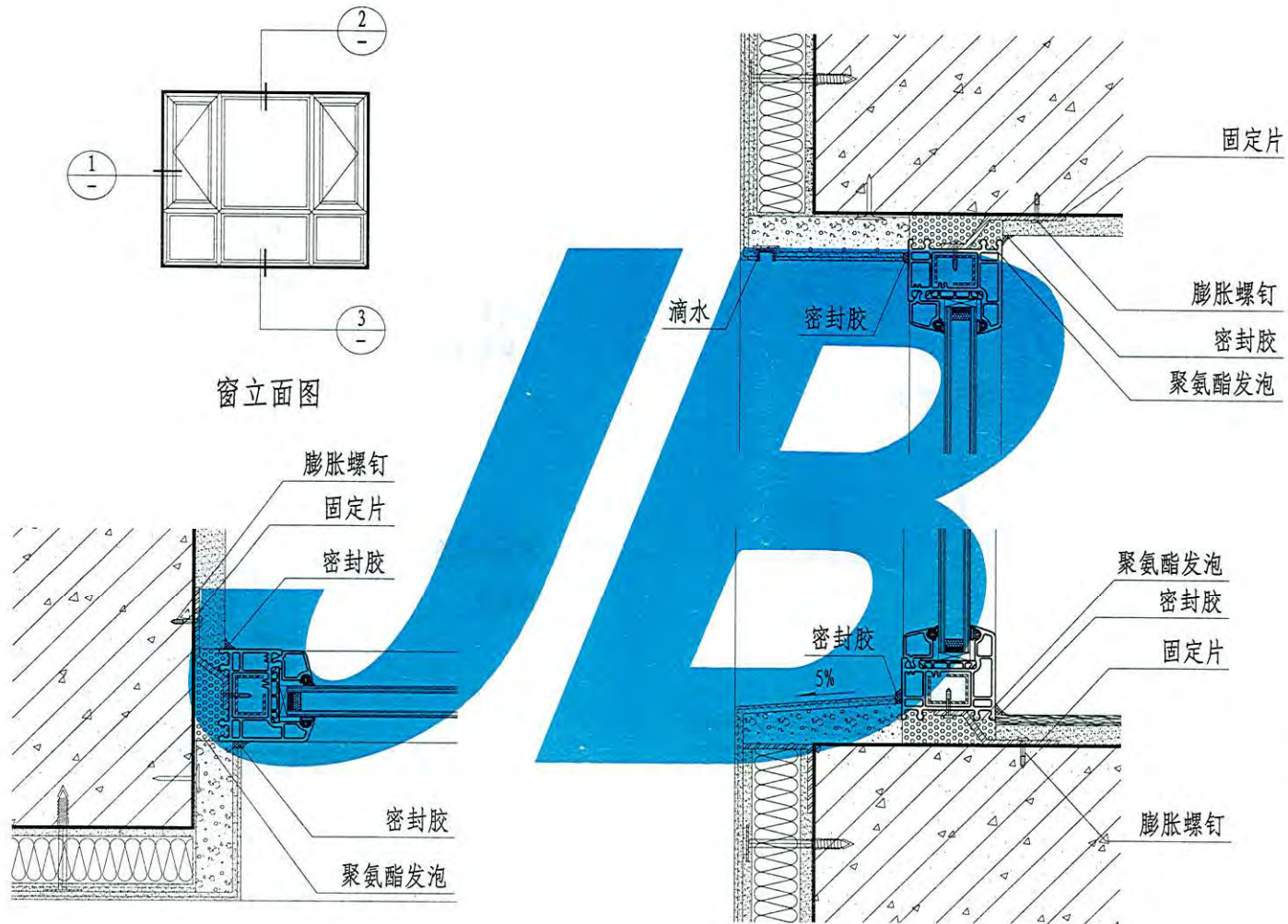

1

2

3

塑料窗框沿墙体中部安装节点图		图集号	12YJ4-1
		页次	65

张晓洁  
核  
刘鹰  
审  
对  
王玉珏  
校  
王玉珏  
设计  
王玉珏  
图  
王玉珏

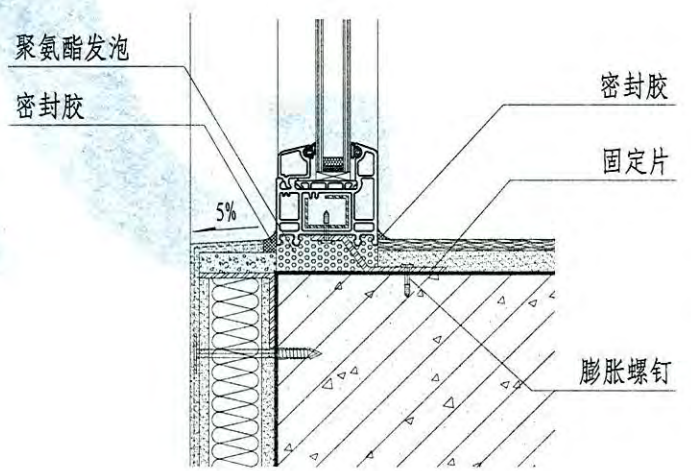
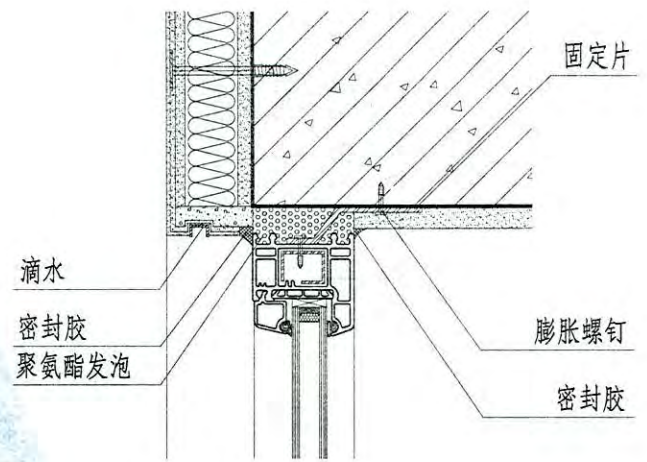
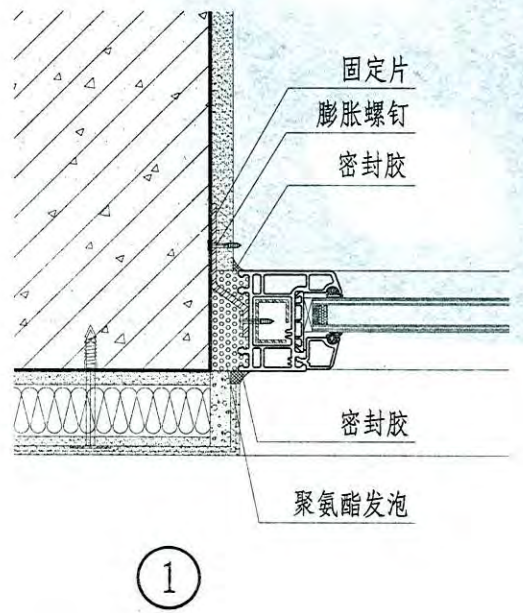
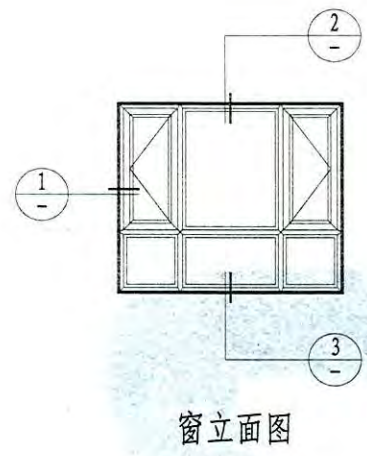

塑料窗框沿墙体外 侧安装节点图		图集号	12YJ4-1
		页次	66

张晓洁  
核  
刘鹰  
对  
侯红霞  
计  
侯红霞  
图

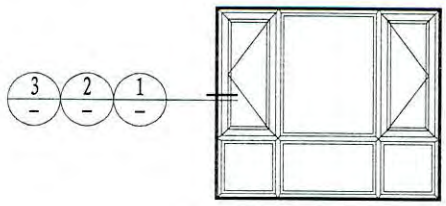

窗立面图

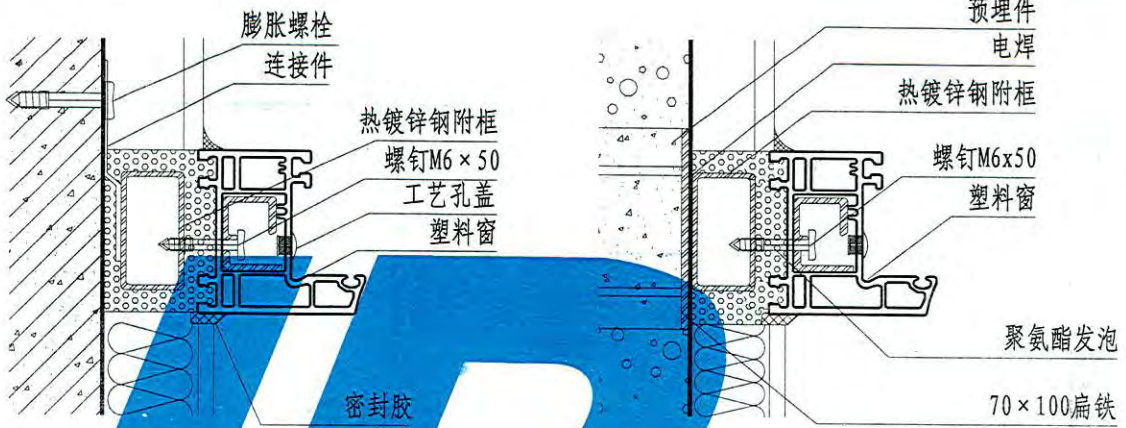

① 混凝土附框安装

② 轻质墙体附框安装

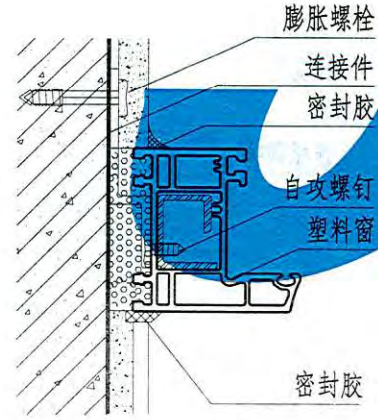

(a)

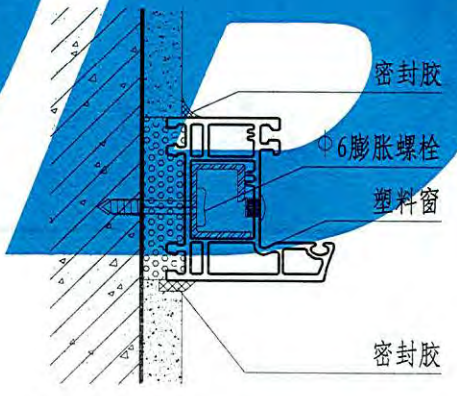

(b)

③ 钢筋混凝土墙体

- 注: 1. 连接件尺寸 $\geq 140 \times 20 \times 1.5$   
 2. 焊接板尺寸 $\geq 140 \times 20 \times 1.5$   
 3. 金属膨胀螺栓 $\geq M6 \times 65$   
 塑料锚栓套管外径7~10mm  
 4. 射钉 $\geq 3.7 \times 42$   
 5. 附框仅为示意, 具体详见工程设计

塑料门窗通用安装节点图

图集号	12YJ4-1
页次	67



张晚洁  
核  
刘鹰岚  
校  
王玉珏  
设计  
王玉珏  
图制

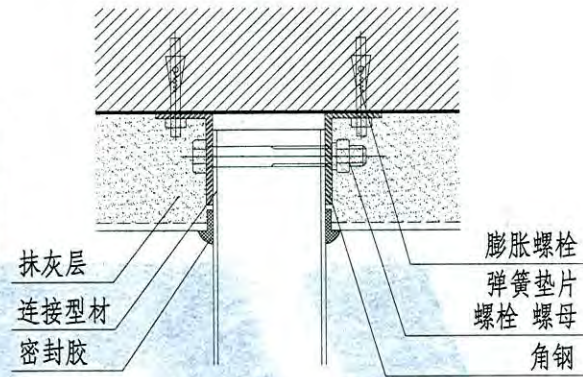
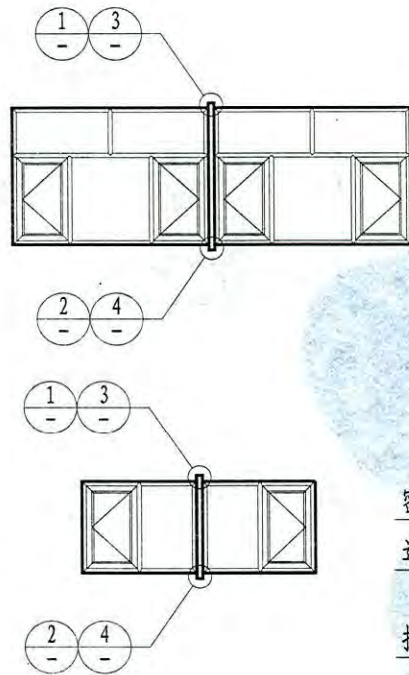

①

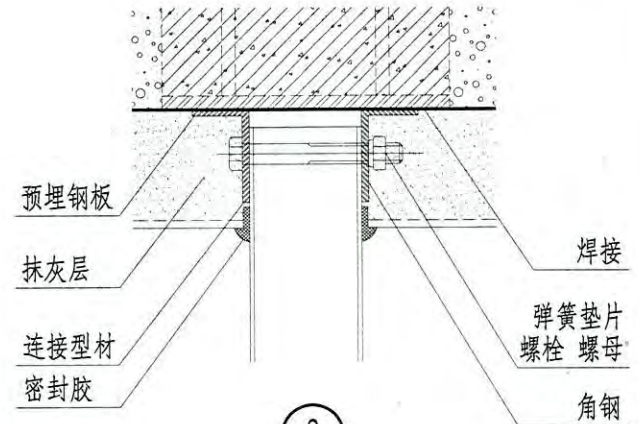

③

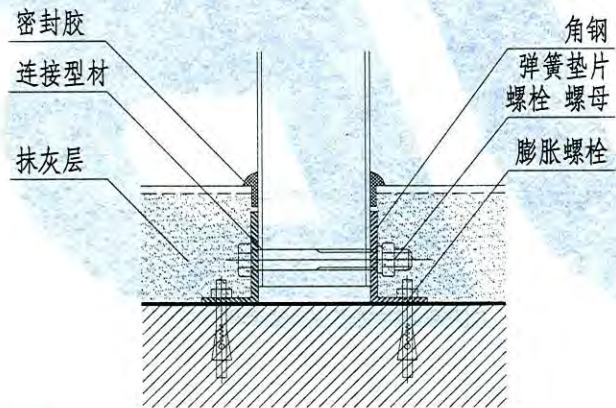

②

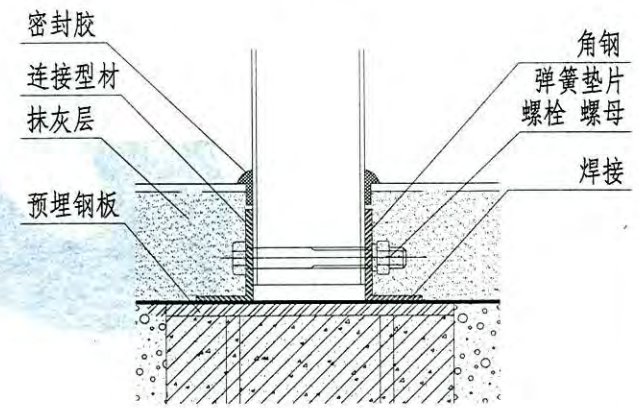

④

- 注：1. 型材与墙体间连接牢固，不得松动。  
2. 型材与墙体间的安装可参照基本窗安装方法。  
3. 连接件需进行防腐处理。  
4. 固定连接件尺寸见单体工程。

组合窗拼接安装节点图

图集号	12YJ4-1
页次	68

张亮洁

核  
审

侯红霞

对  
校

曹越

计  
设

曹越

图  
制

## E型-玻璃钢节能门窗说明

### 1. 编制依据

《玻璃纤维增强塑料(玻璃钢)门》(JG/T 185-2006)

《玻璃纤维增强塑料(玻璃钢)窗》(JG/T 186-2006)

### 2. 编制内容

2.1 推拉门、门连窗、内平开窗的构造节点示意图。

2.2 本图集以中空玻璃表示,也可以安装三层玻璃,具体选用可根据工程需要确定。

2.3 门窗构造尺寸由门、窗生产厂家根据工程实际需要进行调整。

### 3. 适用范围及特点

3.1 适用范围:玻璃钢门窗具有质轻高强、密闭性强、保温性好、耐腐蚀等优点。尤其适合使用于多雨、潮湿、有腐蚀性介质场所和沿海地区及寒冷、严寒地区。

3.2 技术特点:玻璃纤维增强塑料(玻璃钢)门窗,一般采用热固性不饱和树脂为基体材料,加入一定量矿物填料,以玻璃纤维无捻粗纱和其它织物为增强材料,拉挤时经模具加热固化成型,作为门窗框杆件。型材表面经打磨后,可用静电粉末喷涂、表面覆膜等多种工艺处理。

### 4. 技术要求

玻璃钢门窗的力学性能应符合《玻璃纤维增强塑料(玻璃钢)窗》JG/T186、《玻璃纤维增强塑料(玻璃钢)门》JG/T185的要求,具体见表4-1~表4-4。

表 4-1 推拉门的力学性能

项目	技术要求
开关力	不大于100N
弯曲	在300N力作用下,允许有不影响使用的残余变形,试件不损坏,仍保持使用功能
扭曲	在200N力作用下,试件不损坏,允许有不影响使用的残余变形
开关疲劳	经不少于100000次的开关试验,试件及五金件不损坏,其固定处及玻璃压条等不松脱,仍保持使用功能
角联接强度	门框不小于3000N,门扇不小于4000N
软物冲击	试验后无损坏,启闭功能正常
硬物冲击	试验后无损坏
注:1. 无凸出把手的推拉门不做扭曲试验。 2. 全玻璃门不检测软、硬物的冲击性能。	

表 4-2 平开门的力学性能

项目	技术要求
锁紧器(执手)的开关力	不大于80N(力矩不大于10N·m)
开关力	不大于80N
悬端吊重	在500N力作用下,残余变形不大于2mm,试件不损坏,仍保持使用功能
翘曲	在300N力作用下,允许有不影响使用的残余变形,试件不损坏,仍保持使用功能
开关疲劳	经不少于100000次的开关试验,试件及五金件不损坏,其固定处及玻璃压条不松脱,仍保持使用功能

E型-玻璃钢节能门窗说明(一)

图集号

12YJ4-1

页次

69

张皓  
侯红霞  
曹越

核  
审  
校  
越

曹越

计  
设  
制

续表 4-2

项目	技术要求
大力关闭	经模拟7级风开关10次, 试件不损坏, 仍保持开关功能
角联接强度	门框不小于3000N, 门扇不小于6000N
垂直荷载强度	当施加30kg荷载, 门扇卸荷后的下垂量不应大于2mm
软物冲击	无破损, 开关功能正常
硬物冲击	无破损

注: 1. 垂直荷载强度适用于平开门。  
2. 全玻门不检测软、硬物体的冲击性能。

表 4-3 平开窗、上悬窗、中悬窗、下悬窗的力学性能

项目	技术要求
锁紧器(执手)的开关力	不大于80N(力矩不大于10N·m)
开关力	平合页不大于80N, 摩擦铰链不小于30N、不大于80N
悬端吊重	在500N力作用下, 残余变形不大于2mm, 试件不损坏, 仍保持使用功能
翘曲	在300N力作用下, 允许有不影响使用的残余变形, 试件不损坏, 仍保持使用功能
开关疲劳	经不少于10000次的开关试验, 试件及五金件不损坏, 其固定处及玻璃压条等不松脱, 仍保持使用功能
大力关闭	经模拟7级风连续开关10次, 试件不损坏, 仍保持开关功能
角联接强度	窗框不小于2000N, 窗扇不小于2500N
窗撑试验	在200N力作用下, 不允许位移, 连接处型材不破裂
开启限位装置(制动器)受力	在10N力作用下开启10次, 试件不损坏

注: 大力关闭只检测平开窗和上悬窗。

表 4-4 推拉窗的力学性能

项目	技术要求
开关力	推拉窗不大于100N, 上下推拉窗不大于135N
弯曲	在300N力作用下, 允许有不影响使用的残余变形, 试件不损坏, 仍保持使用功能
扭曲	在200N力作用下, 试件不损坏, 允许有不影响使用的残余变形
开关疲劳	经不少于10000次的开关试验, 试件及五金件不损坏, 其固定处及玻璃压条不松脱, 仍保持使用功能
角联接强度	窗框不小于2500N, 窗扇不小于1400N

注: 没有凸出把手的推拉窗不再做扭曲试验。

5. 材料的质量要求

5.1 门窗采用异型材, 应符合现行的行业标准《门窗用玻璃纤维增强塑料拉挤中空型材》JC/T941有关规定。门窗用密封条等原材料应符合国家现行标准的有关规定。

5.2 门窗采用的紧固件、五金件、金属组角及金属衬板等, 应进行防腐处理, 五金件型号、规格和性能均应符合国家现行标准的有关规定, 滑撑铰链不得用铝合金材料。

5.3 玻璃的品种、规格及质量应符合国家现行产品标准的规定, 并应有产品出厂合格证。

5.4 门窗与洞口密封用密封胶应具有弹性和粘结性。

6. 安装和验收: 应符合现行国家有关标准规范的规定以及行业标准的有关规定, 并应具有产品合格证。

张陈洁  
核  
刘鹰岚  
审  
刘燕  
对  
刘燕  
设计  
刘燕  
制图

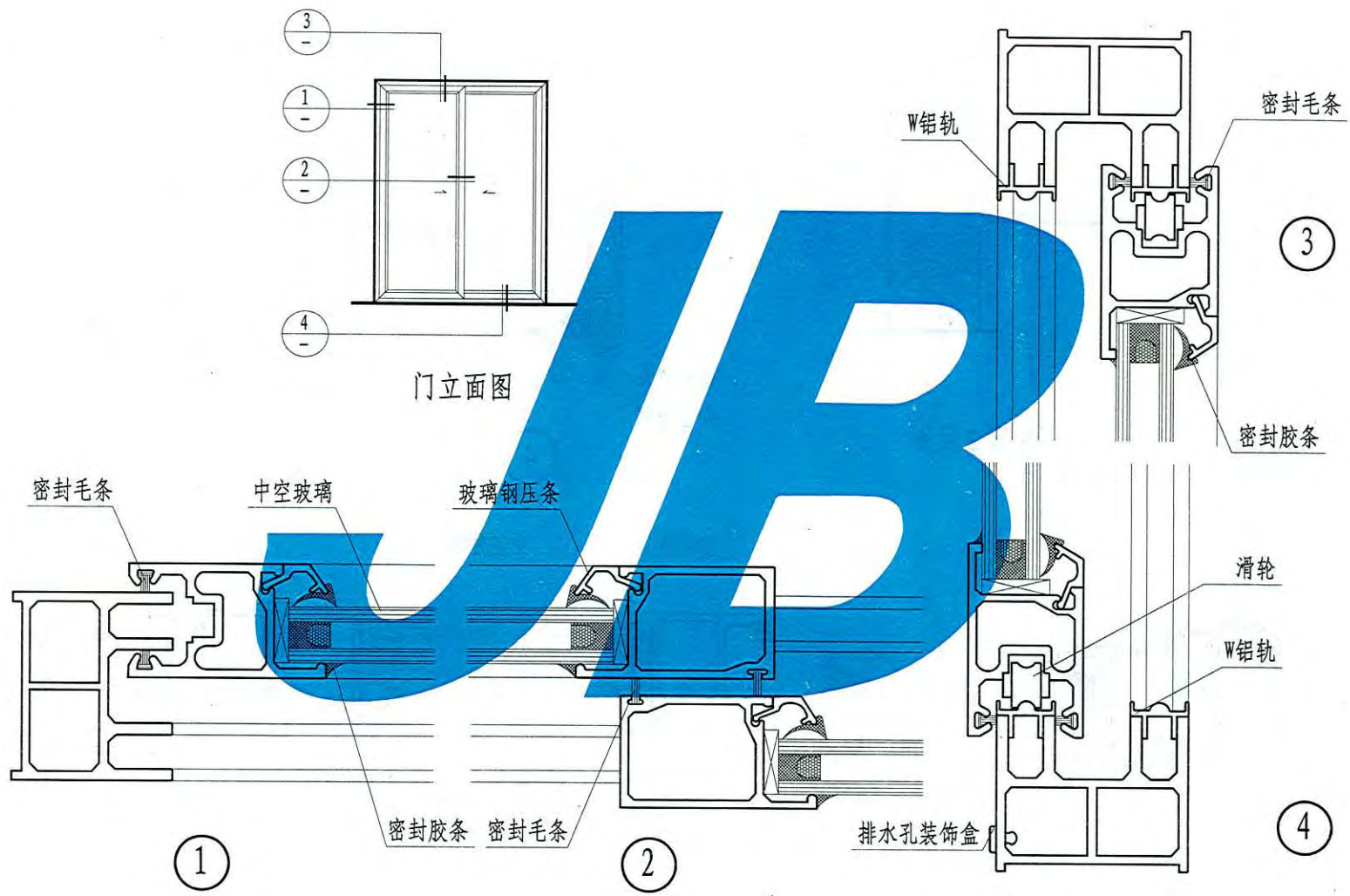

E型—玻璃钢推拉门节点图	图集号	12YJ4-1
	页次	71

张皓洁	张皓洁
核	核
刘鹰岚	刘鹰岚
对	对
刘燕	刘燕
设计	设计
刘燕	刘燕
制	制

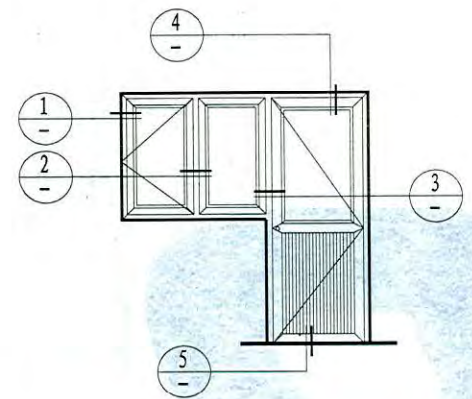

门连窗立面图

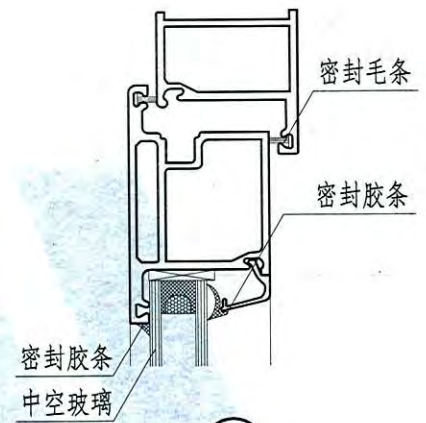

4

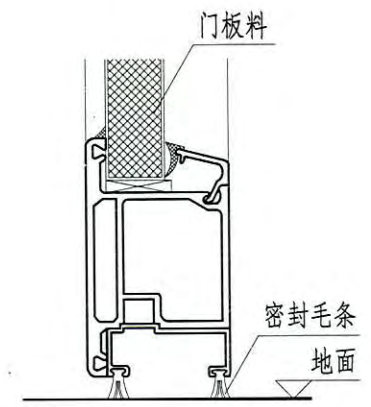

5

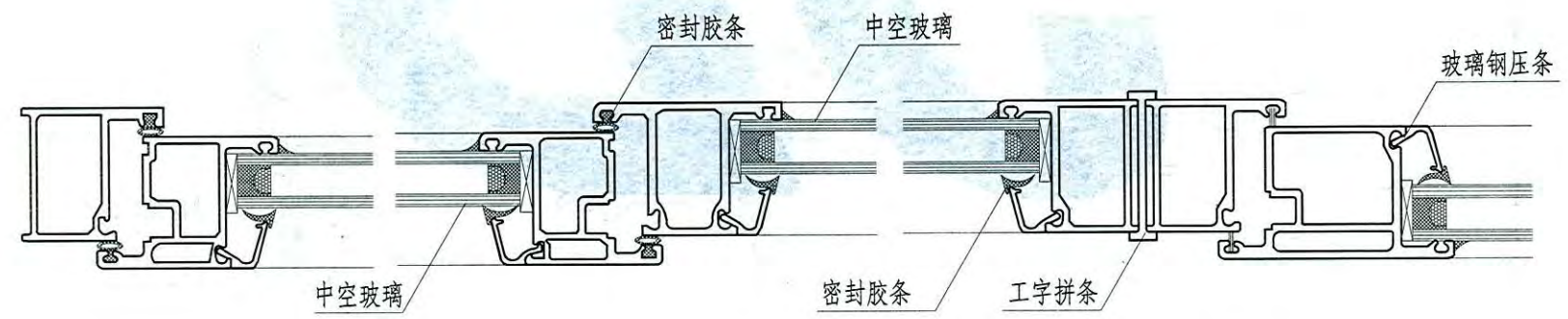

1

2

3

E型—玻璃钢阳台门连窗		图集号	12YJ4-1
节点图(无槛)		页次	72



张 洁	张 洁
核 审	
刘 凤	刘 凤
对 校	
侯 霞	侯 霞
计 设	
侯 霞	侯 霞
图 制	

## F型 - 木门窗说明

1. 编制依据  
《建筑木门、木窗》 (JG/T 122-2000)  
《木结构工程施工质量验收规范》 (GB 50206-2012)

2. 适用范围  
本图集的木门窗适用于一般工业与民用建筑的内门窗。

3. 类型  
本图集木门分为：平开夹板门、平开条形玻璃门、平开实木花格镶整玻璃门、平开镶板门、平开半玻镶板门、平开全玻门、模压门、弹簧镶玻璃门；木窗分为：平开窗、推拉窗。

4. 材料

4.1 木材：选用红松、落叶松等树种的一、二等木材，其选用木材的品种、材质等级以及干燥处理、含水率、检验、保管及成品的运输等要求均应符合《建筑木门、木窗》JG/T122标准。

夹板门的面板可用五层优质胶合板或中密度纤维板，其质量应符合《胶合板》GB/T9846.1~9846.8 II类的要求或《中密度纤维板》GB/T11718中的要求。

实木镶板门的镶板可用实木板、七层胶合板或中密度纤维板。

模压门面板是一种带有线脚图案的高密度纤维板，该产品充分地利用木材资源，有利于环境保护。

本图集门窗用料尺寸主要为常用的普通门窗，门框长度应按下端埋入20mm制作。

4.2 辅助材料：

4.2.1 胶粘剂  
胶粘剂质量应符合相关品种胶粘剂的国家标准及行业标准的规定。

4.2.2 油漆  
油漆质量应符合相关品种油漆的国家标准及行业标准的规定。油性木器漆中有害物质限量应符合《室内装饰装修材料溶剂型木器涂料中有害物质限量》GB18581的规定。

4.2.3 饰面材料  
可选用薄木皮、浸渍胶膜纸饰面人造板、PVC贴面板等，应按设计要求和功能要求选用。有害物质限量应符合相应国家标准规定。

4.2.4 甲醛释放量  
选用的各种胶合材甲醛释放量应符合《室内装饰装修材料人造板及其制品中甲醛释放限量》GB18580中规定的E1要求。

4.2.5 密封材料  
密封材料质量应符合相关品种密封材料的国家标准及行业标准。

4.2.6 五金件、附件、紧固件  
五金件、附件、紧固件应满足功能要求，符合相关品种的国家标准及行业标准的规定。

4.3 弹簧门应选用地弹簧，也可选用液压闭门器，在楼层采用地弹簧时要注意楼层面层的厚度，其厚度应大于地弹簧厚度方可埋设。

4.4 推拉门滑轨、滑轮均为市场成品，推拉门门扇应用滑轨内的门挡定位，勿使地上导向轴在门扇滑动方向受到碰撞。

4.5 木门窗成品的质量及其制作偏差应符合《建筑木门、木窗》

F型-木门窗说明（一）	图集号	12YJ4-1
	页次	74

张 晓 洁

核 审

刘 凤 翔

对 校

侯 红 霞

计 设

侯 红 霞

图 制

JG/T122的规定,见表4.5.

表4.5 木门窗成品的尺寸允许偏差 (mm)

成品名称	I (高) 级			II (中) 级 III (普) 级			备 注
	高	宽	厚	高	宽	厚	
木 门 窗 框	±2	+2 -1	±1	±2	±2	±1	以立口尺寸计算
木门扇 (含装木围条的夹板门扇)	+2 -1	+2 -1	±1	±2	+2 -1	±1	以立口尺寸计算
木窗扇 亮窗扇	+2 -1	+2 -1	±1	±2	+2 -1	±1	以立口尺寸计算

注: 高度超过2500mm的厂房木门扇, 高和宽度允许偏差可放宽至±5mm。

4.6 在工程设计及木门窗加工时, 应根据墙体饰面材料、地面材料按表4.6对框口尺寸及门扇高度进行调整。

表4.6 不同地面做法的门扇高度

楼地面材料	门扇高 (mm)
水泥砂浆 (无垫层)	门框口高-5
现浇水磨石	门框口高-15
铺地砖 (无垫层)	门框口高-15 ~ 20
单层实铺木地板 (无垫层)	门框口高-25 ~ 30

注: 本表均以门扇与地面间隙5mm为例。

5. 制作、安装、储运、验收

5.1 门框料、门扇边梃料均可采用短料指接胶合工艺制作, 并应符合

合国家I级标准, 指接处, 不应开榫打孔。

门框、门扇厚度大于50mm的门扇边梃应采用双榫连接, 不要走头时, 宜采用减榫连接, 榫槽应严密嵌合 (榫槽间隙不大于0.5mm), 应用胶结, 并用胶楔加紧。

5.2 装饰面贴面表面外观要求应符合表5.2的规定。

表5.2 装饰面贴面表面外观要求

缺陷名称	缺陷范围	框	公称范围	
			门	扇
			纵横框	门芯板
麻点	直径1mm以下 (距离300mm)	不限	2个	5个
麻面	均匀颗粒, 手感不刮手	—	不限	—
划伤	宽度<0.5mm, 深度不划破PVC饰面长100mm	3条	1条	2条
压痕	凹陷深度<1.5mm, 宽度100mm以下, 不集中	8个	3个	6个
浮贴	粘贴不牢	—	不允许	—
褶皱	局部重叠	—	不允许	—
缺皮	面积不超过5mm <sup>2</sup>	5个	3个	不允许
翘皮	凸起不超过2mm	不限	5个	不允许
亮影/暗痕	面积不超过50mm <sup>2</sup>	不限	2处	3处
离缝	拼接缝隙	≤1mm	≤0.5mm	≤1mm

注: 具体监测方法为目测。

F型-木门窗说明 (二)

图集号 12YJ4-1  
页次 75



张 晓 洁	
核 审	
刘 鹰	
对 校	
侯 红 霞	
计 设	
侯 红 霞	
图 制	

5.3 本图集复合型门扇、模压门扇两侧（单侧）内部均设有门锁安装垫木，制作时应在其外部面板盖上“门锁”字样，安装门锁注意位置。

5.4 木门窗储运时，应储存于清洁、干燥、通风、温度适宜的仓库内，储存时应水平放置，高出地面200以上，防止受潮、变形。运输时防止机械碰撞和日晒雨淋。

木门窗的包装应采用捆扎或包装箱，包箱内应有装箱单和成品检验合格证。

5.5 木门窗的安装应在墙体湿作业硬化后以及隐蔽工程、吊顶工程、墙面工程、水电工程完成后进行，当需要湿作业前进行时，应采取保护措施。门框与墙体连接见115页安装图，并应符合相关现行国家、行业标准规定。

5.6 木门窗的验收按照《建筑装饰装修工程质量验收规范》GB50210执行。木门窗在结合处和安装配件处不得有木节或已填补的木节，胶合板不得脱胶，上冒头应设有透气孔。

制 图 侯红霞 设计 侯红霞 校对 刘鹰岚 审核 张晓洁

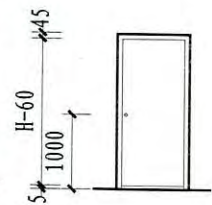

夹板门

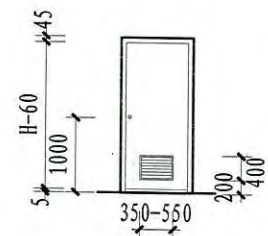

夹板百页门

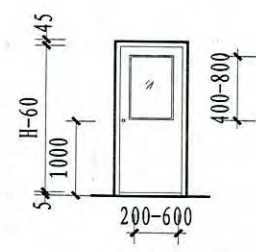

半玻夹板门

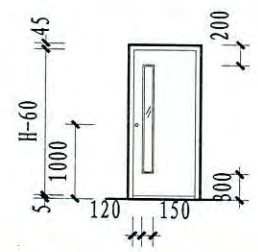

条形玻璃门

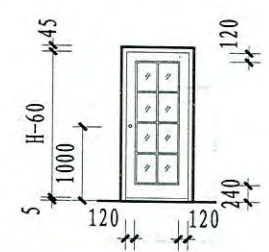

实木花格镶整玻璃门

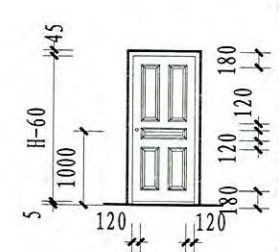

镶板门

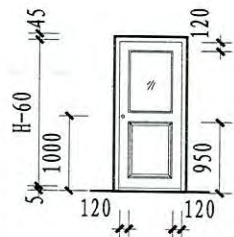

半玻镶板门

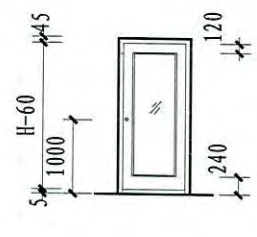

模压门

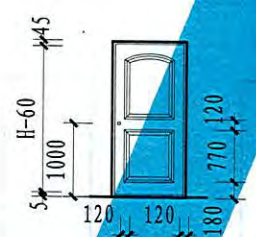

模压门

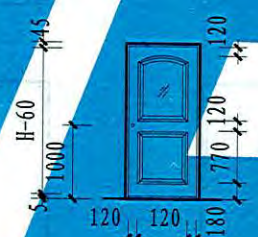

模压门

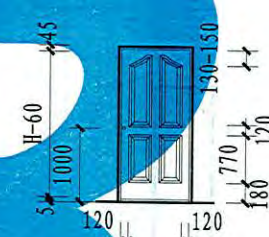

模压门

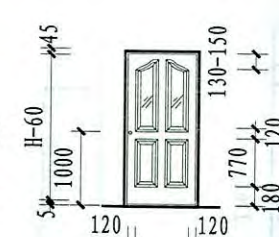

模压门

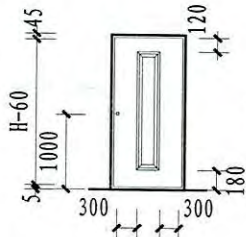

模压门

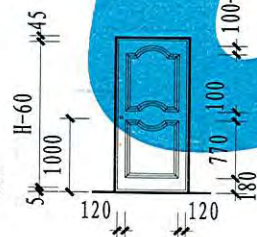

模压门

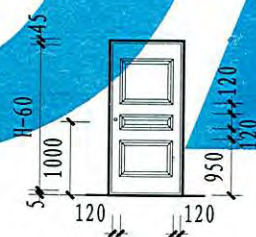

模压门

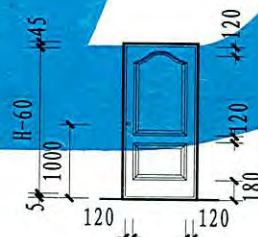

模压门

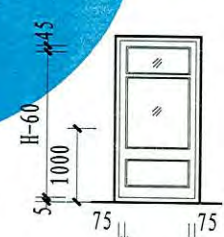



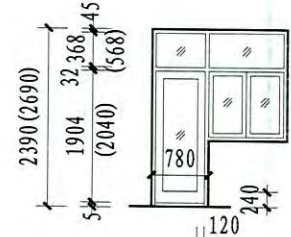













弹簧门





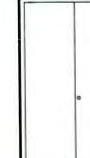
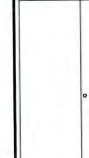



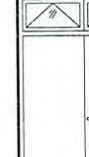



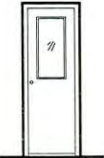







连窗门

木门类型尺寸

图集号 12YJ4-1  
页次 77

		800	900	1000	1200	1500	1800	
张 晓 洁 核 对 刘 鹰 岚 校 对 侯 红 霞 设 计 侯 红 霞 制 图	2100	 PM1-0821	 PM2-0821	 PM-0921	 PM-1021	 PM-1221	 PM-1521	 PM-1821
	2400	 PM1-0824	 PM2-0824	 PM-0924	 PM-1024	 PM-1224	 PM-1524	 PM-1824
	2700			 PM-0927	 PM-1027	 PM-1227	 PM-1527	 PM-1827
注：扫地缝用于浴厕时为 25，用于其它房间时为 5。不适用于潮湿的房间。					平开夹板门立面图			图集号 12YJ4-1 页次 78

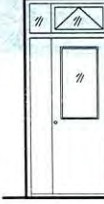
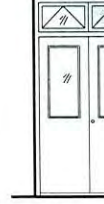









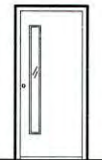
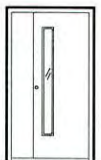
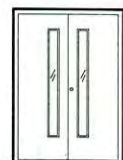

		800	900	1000	1200	1500	1800
张 晓 洁	2100						
刘 蓓 岚		PM-0821	PM-0921	PM-1021	PM-1221	PM-1521	PM-1821
侯 红 霞	2400						
侯 红 霞		PM-0824	PM-0924	PM-1024	PM-1224	PM-1524	PM-1824
制 图	2700						
			PM-0927	PM-1027	PM-1227	PM-1527	PM-1827
注：通风百叶面积应根据通风量计算或凭经验确定。					平开夹板百叶门立面图		图集号 12YJ4-1
							页次 79

制 图		侯 红 霞		设 计		侯 红 霞		校 对		刘 鹰 岚		核 审		张 晓 洁		通 宽
																800
2100									PM-0821	PM-0921	PM-1021	PM-1221	PM-1521	PM-1821	PM-2121	
									PM-0824	PM-0924	PM-1024	PM-1224	PM-1524	PM-1824	PM-2124	
2400										PM-0927	PM-1027	PM-1227	PM-1527	PM-1827	PM-2127	
2700																

注：扫地缝用于浴厕时为 25，用于其它房间时为 5。



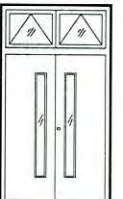
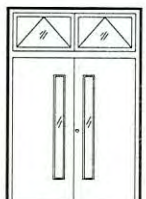

平开半玻夹板门立面图

图集号	12YJ4-1
页次	80



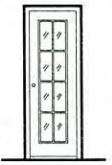
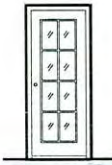
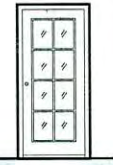
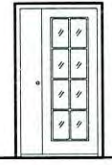
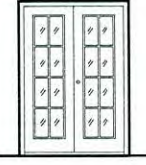
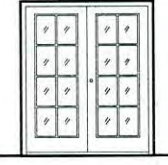
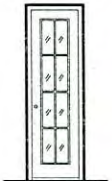
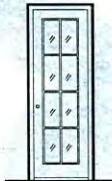
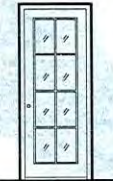
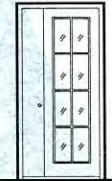
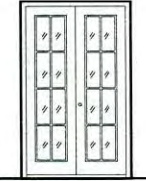



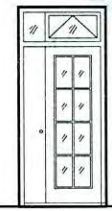
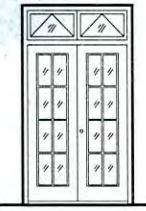
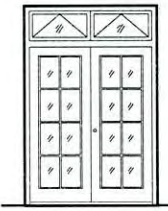



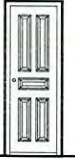
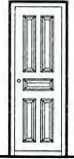









张 晓 洁 张 晓 洁		通 道 宽 度		800	900	1000	1200	1500	1800
		核 对	刘 鹰 岚 刘 鹰 岚	2100					
制 图	侯 红 霞 侯 红 霞	2400							
审 核	侯 红 霞 侯 红 霞	2700							

平开条形玻璃门立面图



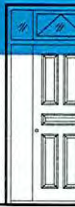



图集号	12YJ4-1
页次	81







洞高	洞宽					
	800	900	1000	1200	1500	1800
2100	 PM-0821	 PM-0921	 PM-1021	 PM-1221	 PM-1521	 PM-1821
2400	 PM-0824	 PM-0924	 PM-1024	 PM-1224	 PM-1524	 PM-1824
2700		 PM-0927	 PM-1027	 PM-1227	 PM-1527	 PM-1827



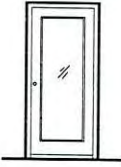
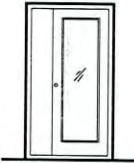
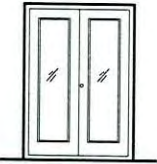
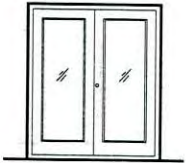
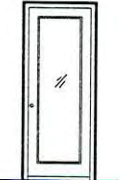



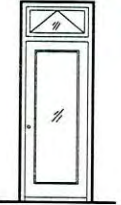

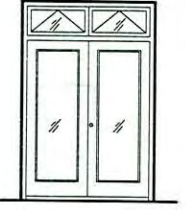

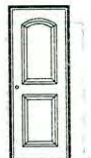
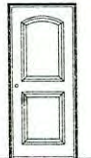
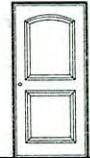

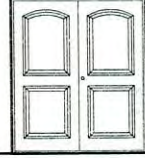
张 晓 洁  
核 审  
刘 鹰 凤  
校 对  
侯 红 霞  
设 计  
侯 红 霞  
制 图

张 晓 洁 核 审 刘 鹰 岚 对 校 侯 红 霞 计 设 侯 红 霞 制 图		洞 宽		800	900	1000	1200	1500	1800	2100
		2100	  PM1-0821    PM2-0821	 PM-0921	 PM-1021	 PM-1221	 PM-1521	 PM-1821	 PM-2121	
2400	  PM1-0824    PM2-0824	 PM-0924	 PM-1024	 PM-1224	 PM-1524	 PM-1824	 PM-2124			
2700		 PM-0927	 PM-1027	 PM-1227	 PM-1527	 PM-1827	 PM-2127			
平开镶板门立面图									图 集 号	12YJ4-1
									页	83

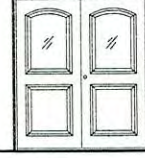
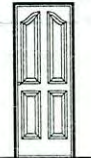
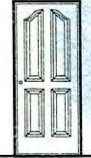
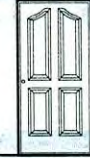

张 晓 洁 核 审 刘 鹰 岚 校 对 侯 红 霞 设 计 侯 红 霞 制 图	2100 	800  PM-0821	900  PM-0921	1000  PM-1021	1200  PM-1221	1500  PM-1521	1800  PM-1821	2100  PM-2121	
	2400 	 PM-0824	 PM-0924	 PM-1024	 PM-1224	 PM-1524	 PM-1824	 PM-2424	
	2700 		 PM-0927	 PM-1027	 PM-1227	 PM-1527	 PM-1827	 PM-2127	
							平开半玻镶板门立面图		图集号 12YJ4-1 页次 84

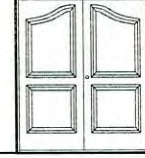
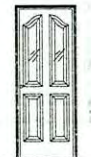
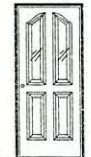
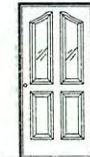
制 图	侯红霞	2700	1000	1200	1500	1800		
	设计		侯红霞	2100	1000	1200	1500	1800
	校 对		刘鹰岚	1000	1200	1500	1800	
核 审	张 晓 洁	2400	1000	1200	1500	1800		
			1000	1200	1500	1800		
			 PM-1021	 PM-1221	 PM-1521	 PM-1821		
			 PM-1024	 PM-1224	 PM-1524	 PM-1824		
			 PM-1027	 PM-1227	 PM-1527	 PM-1827		
平开全玻门立面图						图集号 12YJ4-1 页次 85		

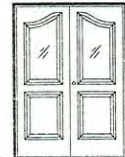
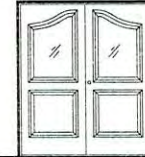





张晚洁 审核		刘鹰凤 校对		侯红霞 设计		侯红霞 制图		2100		800	900	1000	1200	1500	1800
								800	900	1000	1200	1500	1800		
															
															
															
															





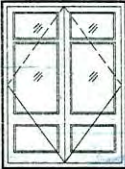
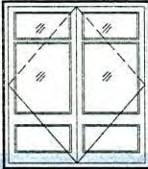
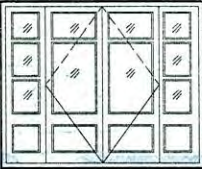
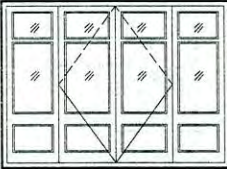

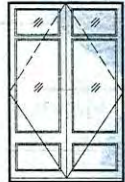
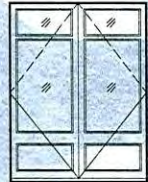
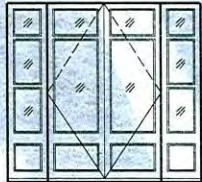
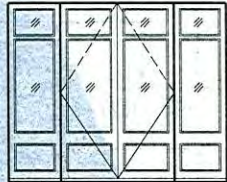
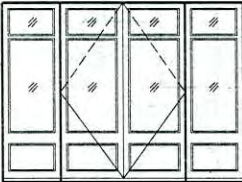
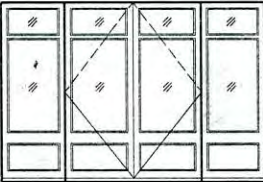
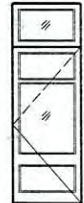
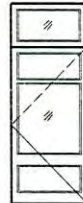
模压门立面图(一)

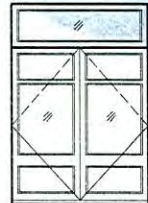
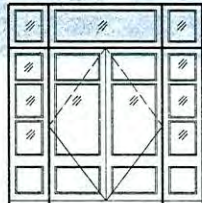
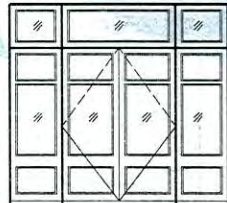
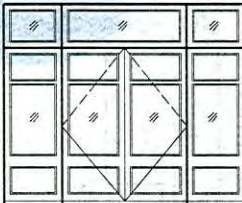
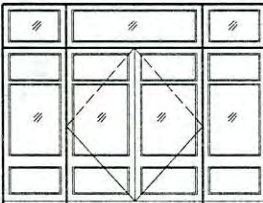
张 晓 洁 核 对		800		900		1000		1200		1500		1800	
		刘 鹰 岚 校 对		侯 红 霞 设 计		侯 红 霞 制 图		2100					
		MY1-0821	MY1-0921	MY1-1021	MY1-1221	MY1-1521	MY1-1821						
		MY2-0821	MY2-0921	MY2-1021	MY2-1221	MY2-1521	MY2-1821						
		MY3-0821	MY3-0921	MY3-1021	MY3-1221	MY3-1521	MY3-1821						
		MY4-0821	MY4-0921	MY4-1021	MY4-1221	MY4-1521	MY4-1821						
注：图中所示立面形式仅为示意，具体形式由设计人定。										模压门立面图（二）		图集号	12YJ4-1
												页次	87

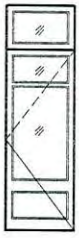

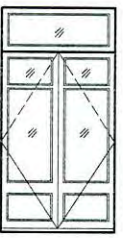
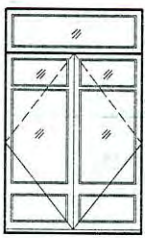
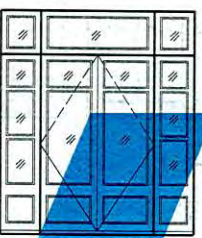
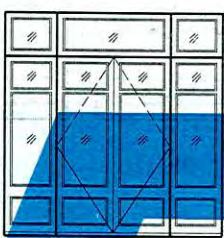
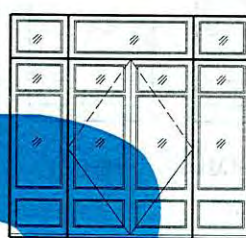
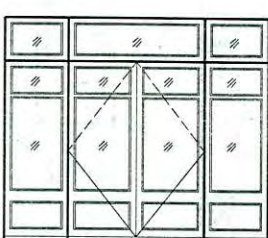
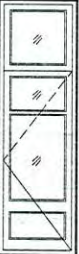

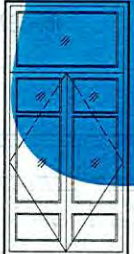

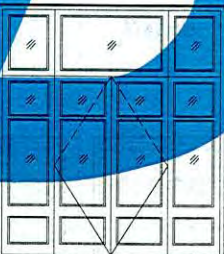
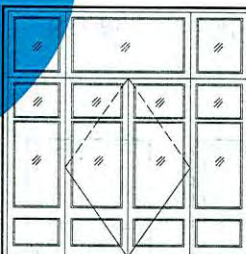
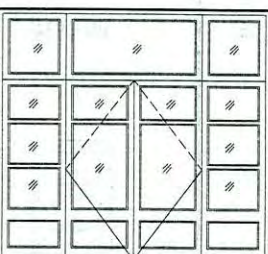

制图 侯红霞 设计 侯红霞 校对 刘鹰岚 审核 张皓洁	2400 	1500 		1800 		2100 	
	2700 						
	2400 						
	2700 						
注：图中所示立面形式仅为示意，具体形式由设计人定。					平开门连窗立面图		图集号 12YJ4-1
							页次 88

制图 侯红霞 设计 侯红霞 校对 刘鹰岚 审核 张晓洁	2400	1500	1800	2100
	2700	 MTC1-1524	 MTC1-1824	 MTC1-2124
	2400	 MTC2-1524	 MTC2-1824	 MTC2-2124
	2700	 MTC1-1527	 MTC1-1827	 MTC1-2127
		 MTC2-1527	 MTC2-1827	 MTC2-2127
注：图中所示立面形式仅为示意，具体形式由设计人定。		平开门连推拉窗立面图		
		图集号 12YJ4-1 页次 89		

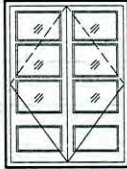
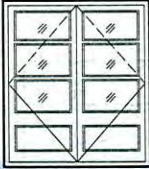
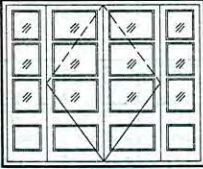
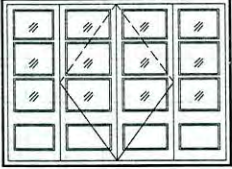
张 晓 洁	核 对	刘 鹰 凤	审 核	新 型 号	900	1000	1500	1800	2700	3000	3300	3600	
				2100									
				HM-0921	HM-1021	HM-1521	HM-1821	HM-2721	HM-3021				
侯 红 霞	制 图	侯 红 霞	设 计	2400									
				HM-0924	HM-1024	HM-1524	HM-1824	HM-2724	HM-3024	HM-3324	HM-3624		
				2700									
					HM-0927	HM-1027	HM-1527	HM-1827	HM-2727	HM-3027	HM-3327	HM-3627	
弹 簧 镶 玻 璃 门 (半截玻璃)立面图(一)											图 集 号	12YJ4-1	
											页 次	90	

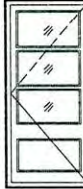
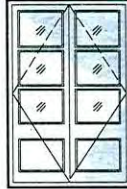
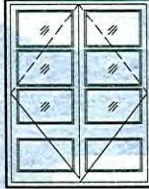
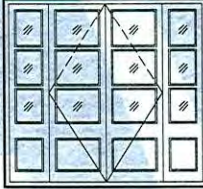
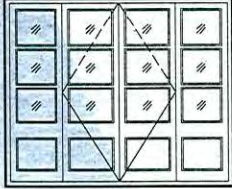
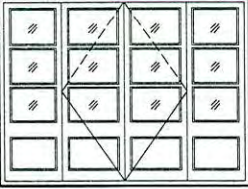
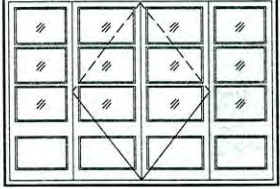
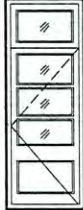
张洁 核 刘凤 校 侯霞 计 侯霞 图	3000	900	1000	1500	1800	2700	3000	3300	3600
	 HM-0930	 HM-1030	 HM-1530	 HM-1830	 HM-2730	 HM-3030	 HM-3330	 HM-3630	
3300	 HM-0933	 HM-1033	 HM-1533	 HM-1833	 HM-2733	 HM-3033	 HM-3333	 HM-3633	
弹簧镶玻璃门 (半截玻璃) 立面图 (二)								图集号	12YJ4-1
								页次	91

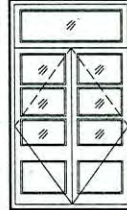

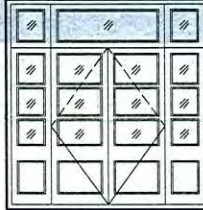
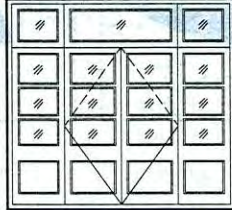
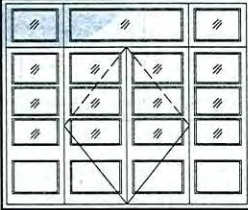
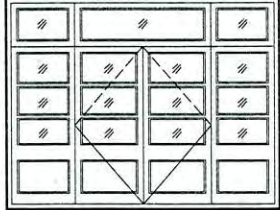
制图	侯红霞	设计	侯红霞	校对	刘鹰岚	审核	张晓洁	通高	900	1000	1500	1800	2700	3000	3300	3600
								2100								
								HM-0921	HM-1021	HM-1521	HM-1821	HM-2721	HM-3021			
制图	侯红霞	设计	侯红霞	校对	刘鹰岚	审核	张晓洁	2400								
								HM-0924	HM-1024	HM-1524	HM-1824	HM-2724	HM-3024	HM-3324	HM-3624	
制图	侯红霞	设计	侯红霞	校对	刘鹰岚	审核	张晓洁	2700								
								HM-0927	HM-1027	HM-1527	HM-1827	HM-2727	HM-3027	HM-3327	HM-3627	
								弹簧镶玻璃门立面图 (三玻一板)(一)								
								图集号		12YJ4-1		页次		92		

制 图	侯红霞 <i>侯红霞</i>	设 计	侯红霞 <i>侯红霞</i>	校 对	刘鹰岚 <i>刘鹰岚</i>	审 核	张晚洁 <i>张晚洁</i>	洞宽	900	1000	1500	1800	2700	3000	3300	3600
								洞高	3000	3000	3000	3000	3000	3000	3000	3000
									HM-0930	HM-1030	HM-1530	HM-1830	HM-2730	HM-3030	HM-3330	HM-3630
									HM-0933	HM-1033	HM-1533	HM-1833	HM-2733	HM-3033	HM-3333	HM-3633
								弹簧镶玻璃门立面图 (三玻一板)(二)								
								图集号		12YJ4-1		页次		93		

张 晓 浩		600	900	1200	1500	1800	2100	2400
核 对	刘 鹰 岚							
校 对	侯 红 霞	PC-0612	PC-0912	PC-1212	PC-1512	PC-1812	PC-2112	PC-2412
设 计	侯 红 霞							
图 制		PC-0615	PC-0915	PC-1215	PC-1515	PC-1815	PC-2115	PC-2415
		PC-0618	PC-0918	PC-1218	PC-1518	PC-1818	PC-2118	PC-2418

平开窗立面图

张 晓 洁	审核	900	1200	1500	1800	2400	2700			
			TC-1209	TC-1509	TC-1809	TC-2409	TC-2709			
刘 鹰 岚	校对	1200								
侯 红 霞	设计		TC-1212	TC-1512	TC-1812	TC-2412	TC-2712			
侯 红 霞	制图		1500							
		TC-1215		TC-1515	TC-1815	TC-2415	TC-2715			
		推拉窗立面图 (一) <table border="1" style="float: right; margin-top: 10px;"> <tr> <td>图集号</td> <td>12YJ4-1</td> </tr> <tr> <td>页次</td> <td>95</td> </tr> </table>					图集号	12YJ4-1	页次	95
图集号	12YJ4-1									
页次	95									

制图	侯红霞	设计	侯红霞	校对	刘鹰岚	审核	张晓洁	1500	1200	900	1200	1500	1800	2400	2700
								TC-1215	TC-1512	TC-1812	TC-2412	TC-2712			
								TC-1215	TC-1515	TC-1815	TC-2415	TC-2715			
TC-1212	TC-1512	TC-1812	TC-2412	TC-2712											
TC-1209	TC-1509	TC-1809	TC-2409	TC-2709											

推拉窗立面图(二)

张 晓 洁  
核 对  
刘 腾 岚  
校 对  
侯 红 霞  
设 计  
侯 红 霞  
制 图

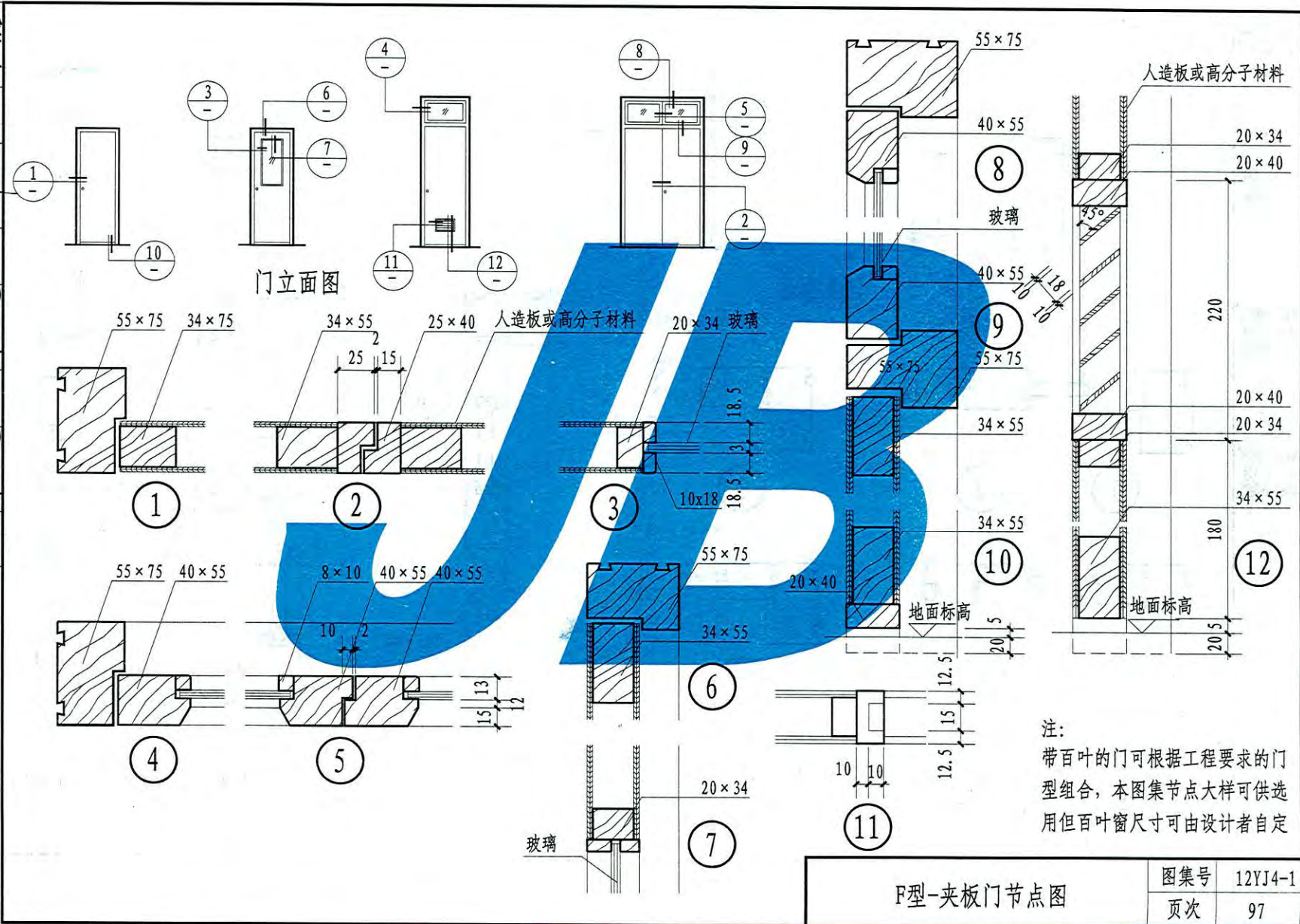

F型-夹板门节点图



张 晓 洁  
核 审  
刘 鹰 凤  
对 校  
侯 红 霞  
计 设  
侯 红 霞  
图 制

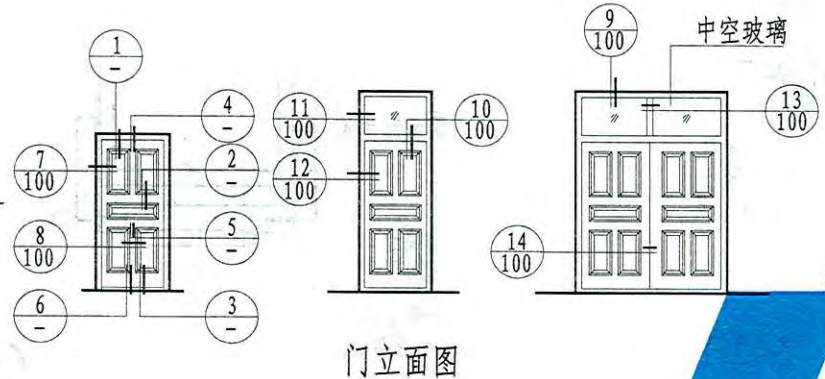

五金材料表

名称规格	洞口编号	0821		1221		0824		1224		1227	
		数量	数量	数量	数量	数量	数量	数量	数量	数量	数量
合页	100	3	6	3	6						
插销	100			2	2						
暗插销	200		2		2						
门锁		1	1	1	1						
门吸		1	2	1	2						
门锁专用紧固件		6	6	6	6						

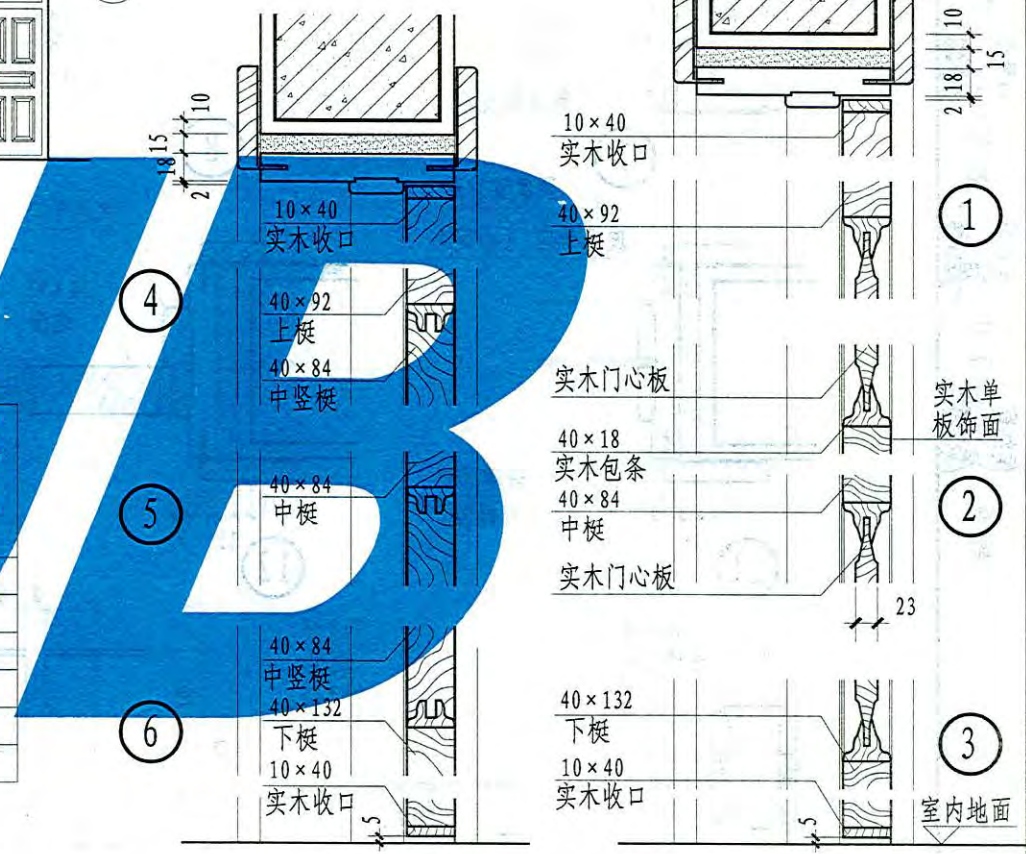



张 晓 洁  
 核 审  
 刘 鹰 岚  
 对 校  
 侯 红 霞  
 计 设  
 侯 红 霞  
 图 制

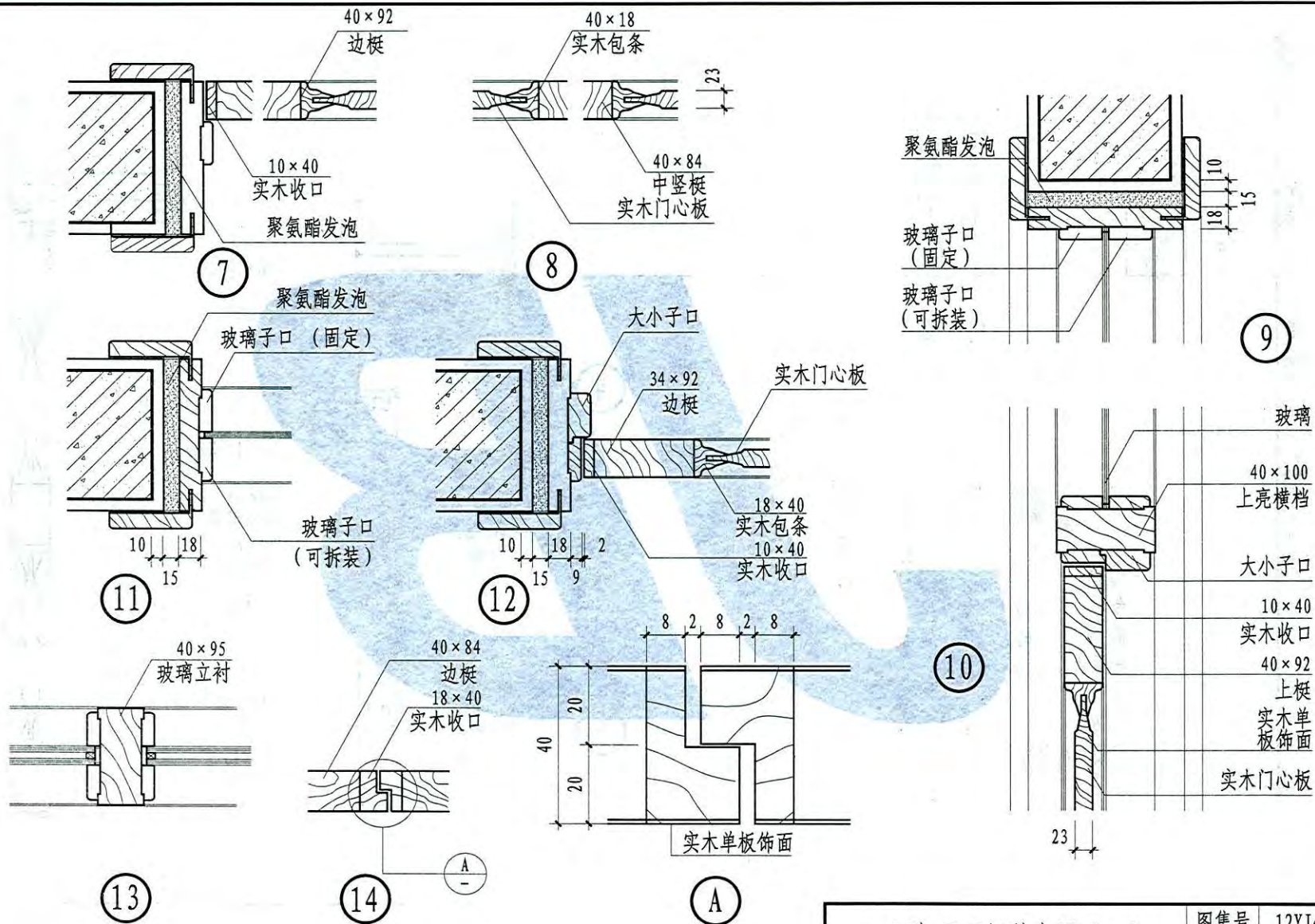

F型-平开门节点图 (二)

图集号	12YJ4-1
页次	100

张晓洁  
核  
刘鹰岚  
校  
侯红霞  
计  
侯红霞  
图  
制

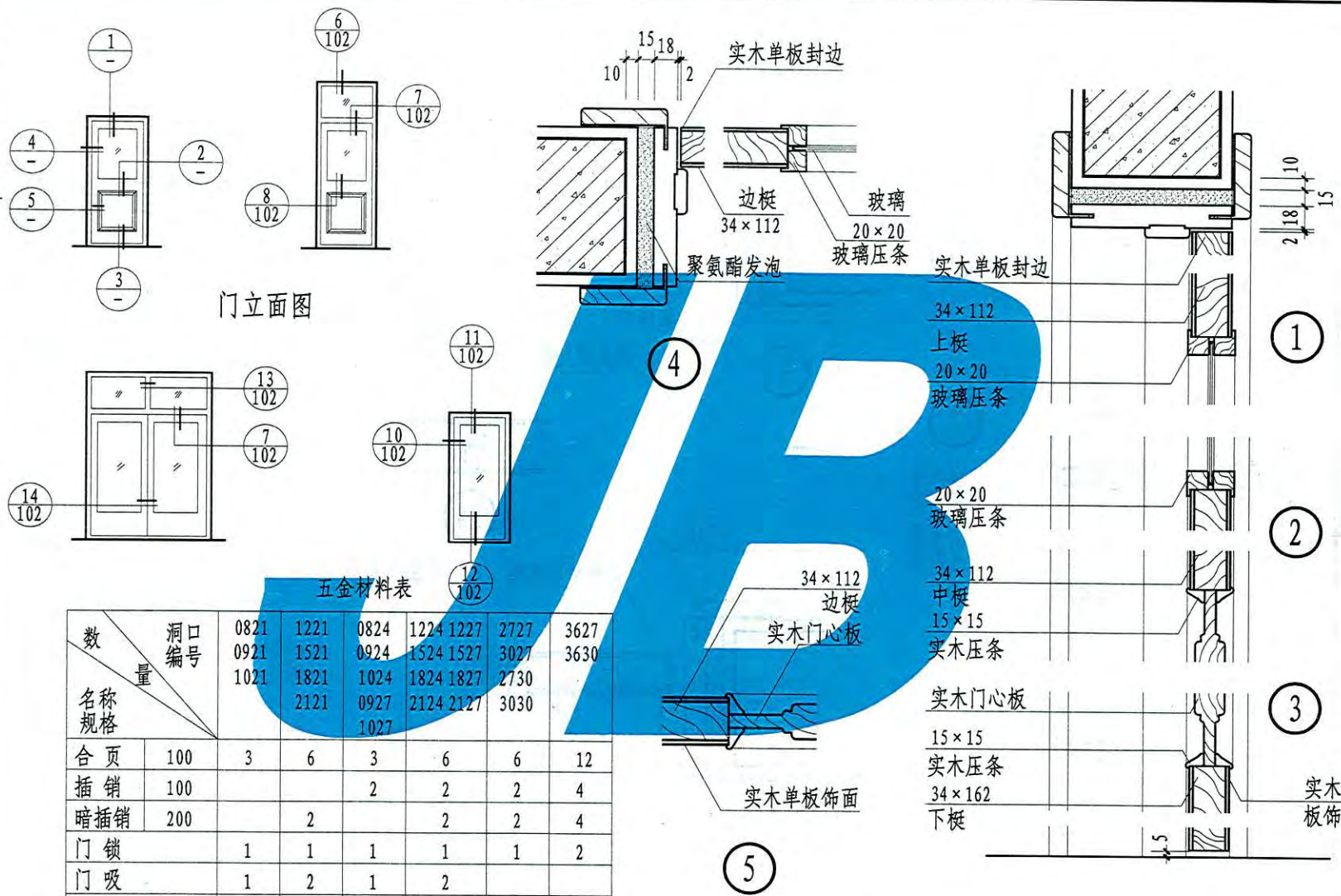

门立面图

五金材料表

名称规格	洞口编号	五金材料表					3627 3630
		0821 0921 1021	1221 1521 1821 2121	0824 0924 1024 0927 1027	1224 1524 1824 2124 2127	1227 1527 1827 2127 3030	
合页	100	3	6	3	6	6	12
插销	100			2	2	2	4
暗插销	200		2		2	2	4
门锁		1	1	1	1	1	2
门吸		1	2	1	2		
拉手						4	8
门锁专用紧固件		6	6	6	6	6	6

张 晓 洁

*[Signature]*

核 审

刘 鹰 岚

*[Signature]*

对 校

侯 红 霞

*[Signature]*

计 设

侯 红 霞

*[Signature]*

图 制

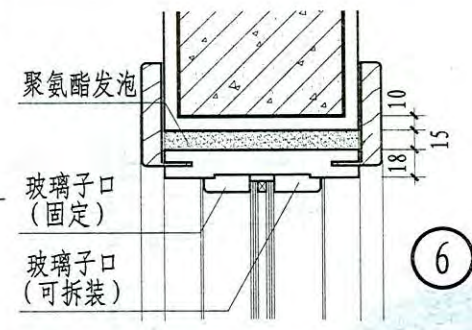

6

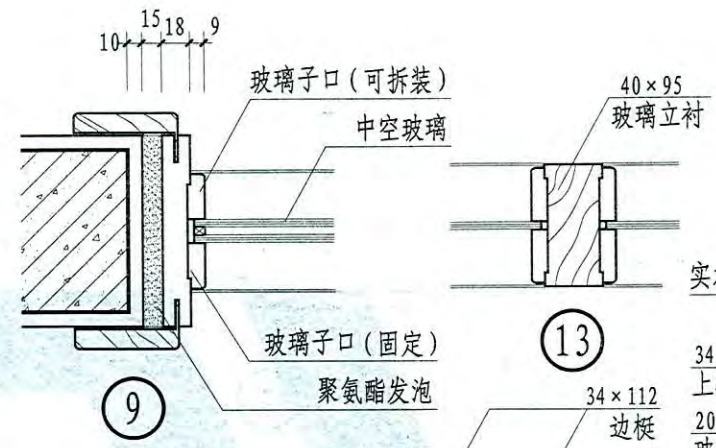

9

13

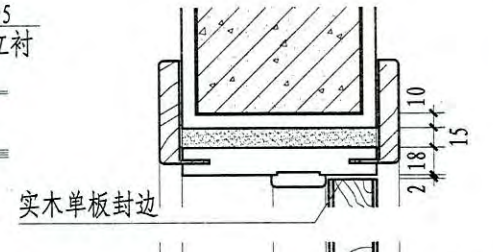

11

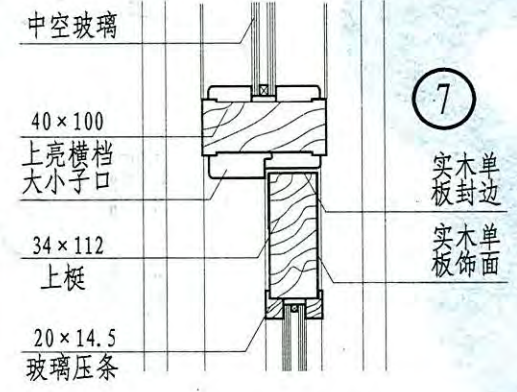

7

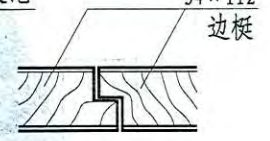

14

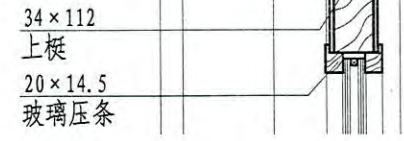

12

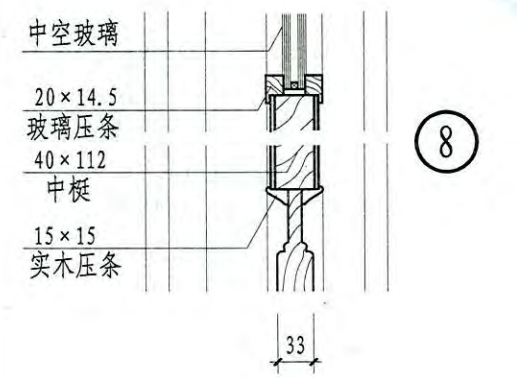

8

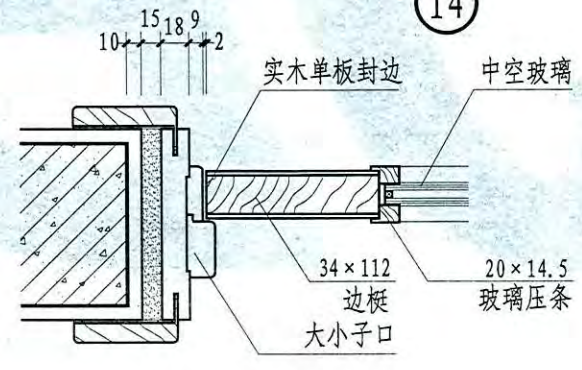

10

F型-平开门节点图 (四)		图集号	12YJ4-1
		页次	102



张晚洁  
核  
刘鹰凤  
审  
侯红霞  
校  
侯红霞  
设计  
侯红霞  
制

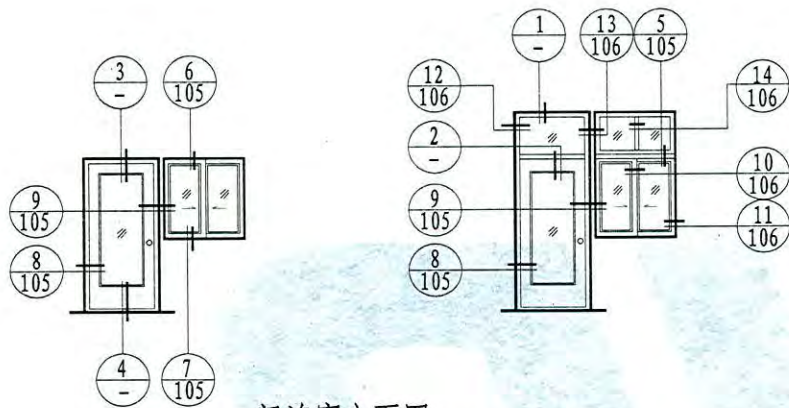

门连窗立面图

五金材料表

名称规格	洞口编号	1821	2421
合页	100	3	
下滑轨		4	
下滑轮		2	
门锁		1	
门吸		1	
门、窗套专用紧固件		14	

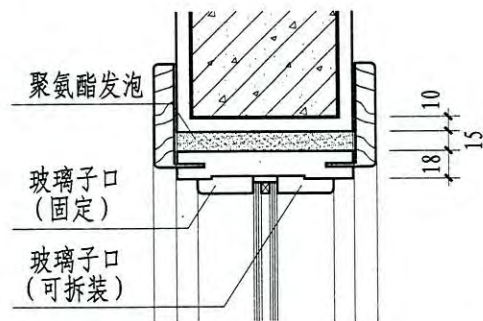
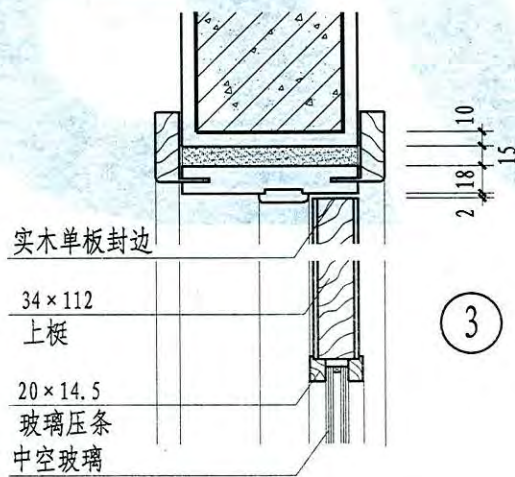

1

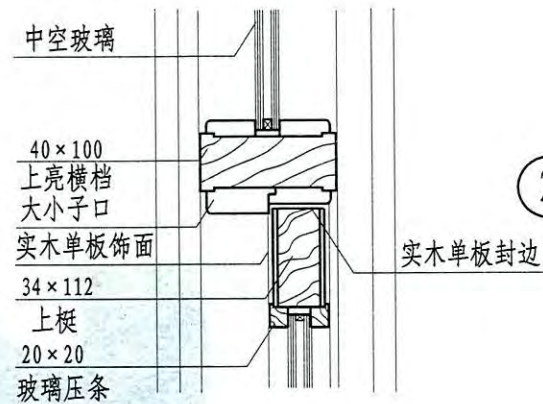

2

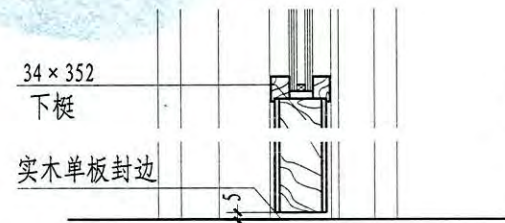

4

张 晓 洁  
核 审  
刘 鹰 翔  
对 校  
侯 红 霞  
计 设  
侯 红 霞  
图 制

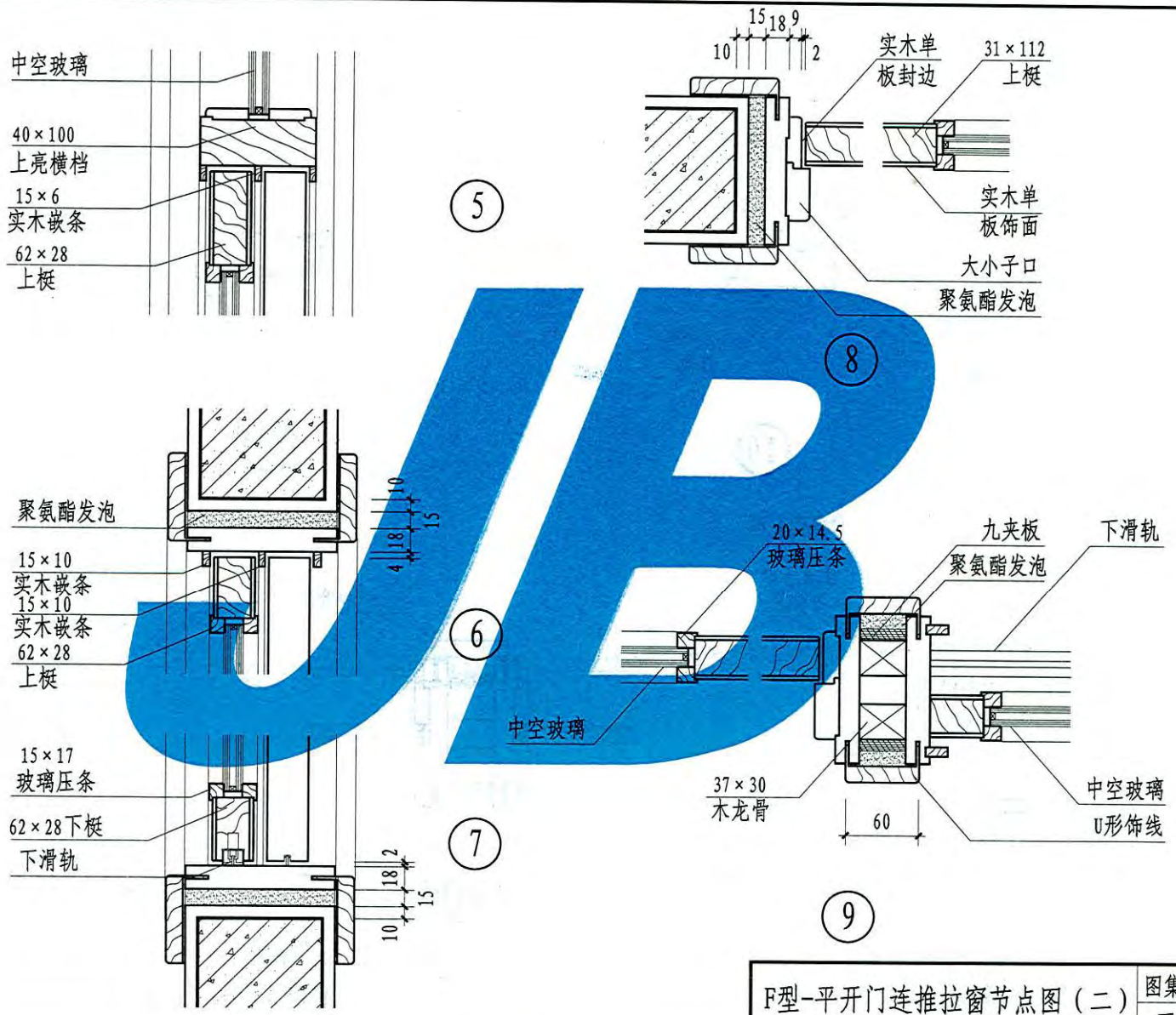

F型-平开门连推拉窗节点图(二)	图集号	12YJ4-1
	页次	105

制图	侯红霞
设计	侯红霞
校对	侯红霞
审核	刘鹰岚
张晚洁	张晚洁

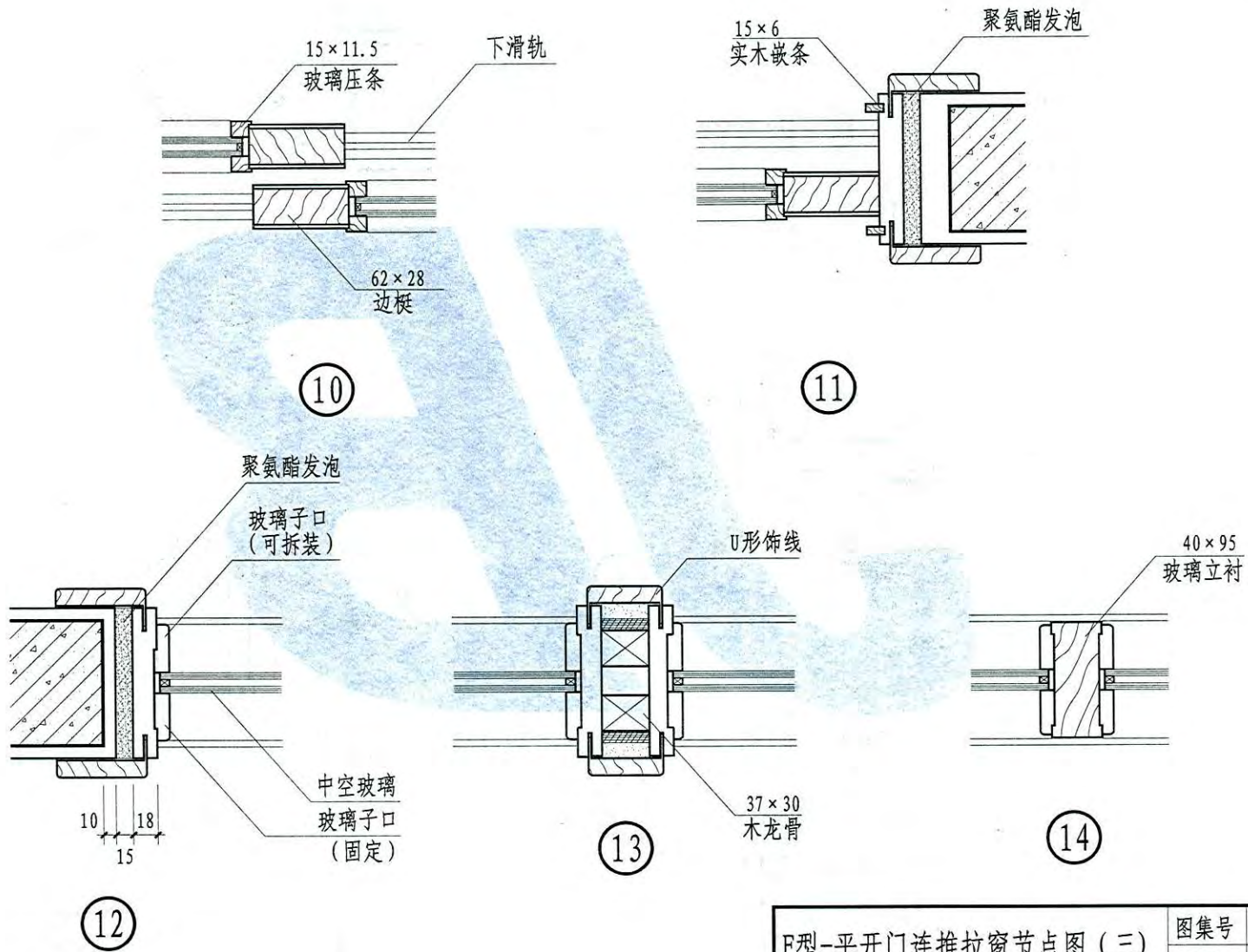

F型-平开门连推拉窗节点图 (三)

图集号	12YJ4-1
页次	106

张 晓 洁  
核 审  
刘 鹰 凤  
对 校  
侯 红 霞  
计 设  
侯 红 霞  
图 制

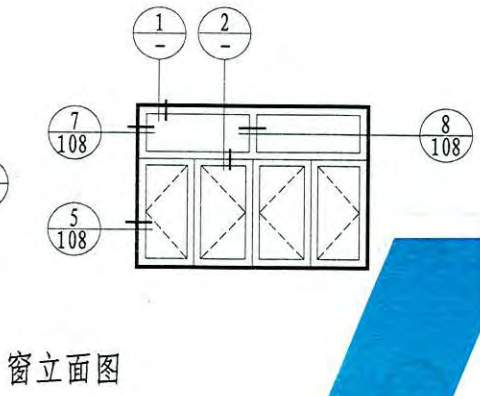
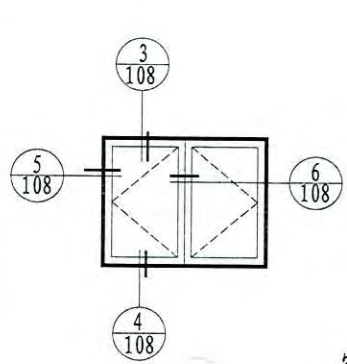

窗立面图

五金材料表

数 量	洞口 编号	0606		0906 1206		1506 1806		2106 2406	
		0609	0909	1209	1509	1809	2109	2409	
名称	规格	0612	0912	1212	1512	1812	2112	2412	
		0614	0914	1214	1514	1814	2114	2414	
		0615	0915	1215	1515	1815	2115	2415	
		0618	0918	1218	1518	1818	2118	2418	
合页		2	4		4		8		
插销		2	2		4		4		
拉手		1	1		2		2		
风钩		1	2		2		4		
窗套专用紧固件		8	8		8		8		

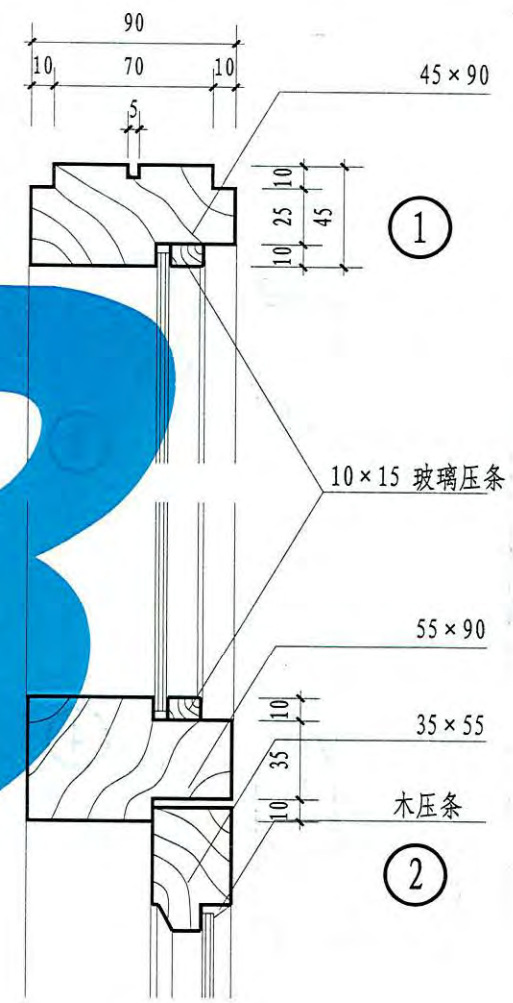





张 晓 洁  
核 审  
刘 鹰 岚  
对 校  
侯 红 霞  
计 设  
侯 红 霞  
图 制

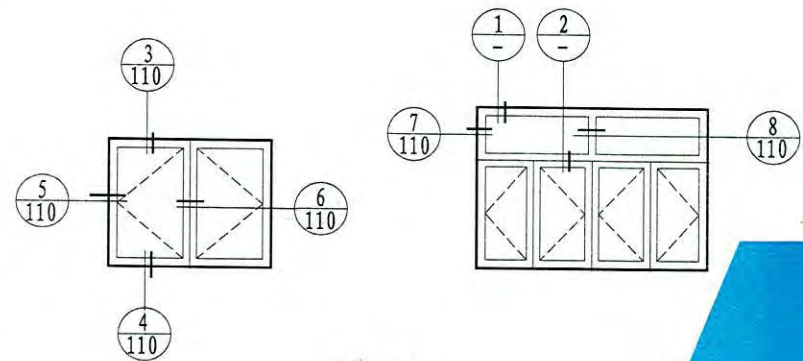

窗立面图

五金材料表

数 量	洞 口 编 号	0606		0906		1206		1506		1806		2106		2406	
		0609	0909	1209	1509	1809	2109	2409	0612	0912	1212	1512	1812	2112	2412
名称	规格	0614	0914	1214	1514	1814	2114	2414	0615	0915	1215	1515	1815	2115	2415
		0618	0918	1218	1518	1818	2118	2418							
合 页		2	4		4		8								
插 销		2	2		4		4								
拉 手		1	1		2		2								
风 钩		1	2		2		4								
窗套专用紧固件		8	8		8		8								

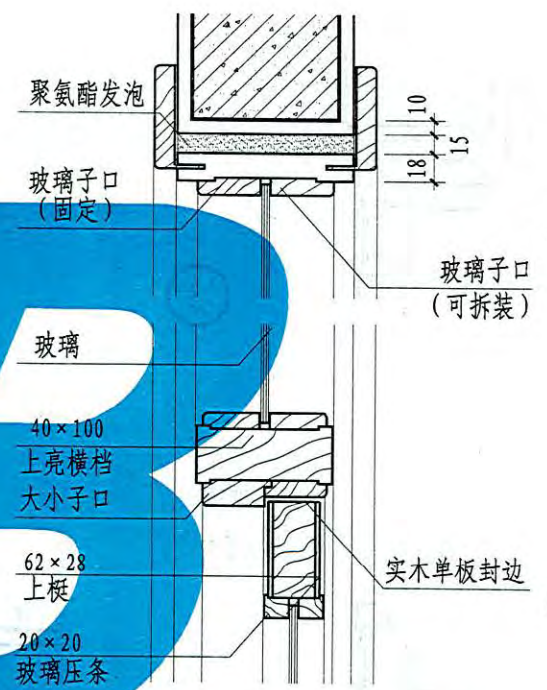

①

②

张 晓 洁  
 核 审  
 刘 鹰 岚  
 校 对  
 侯 红 霞  
 设 计  
 侯 红 霞  
 制 图

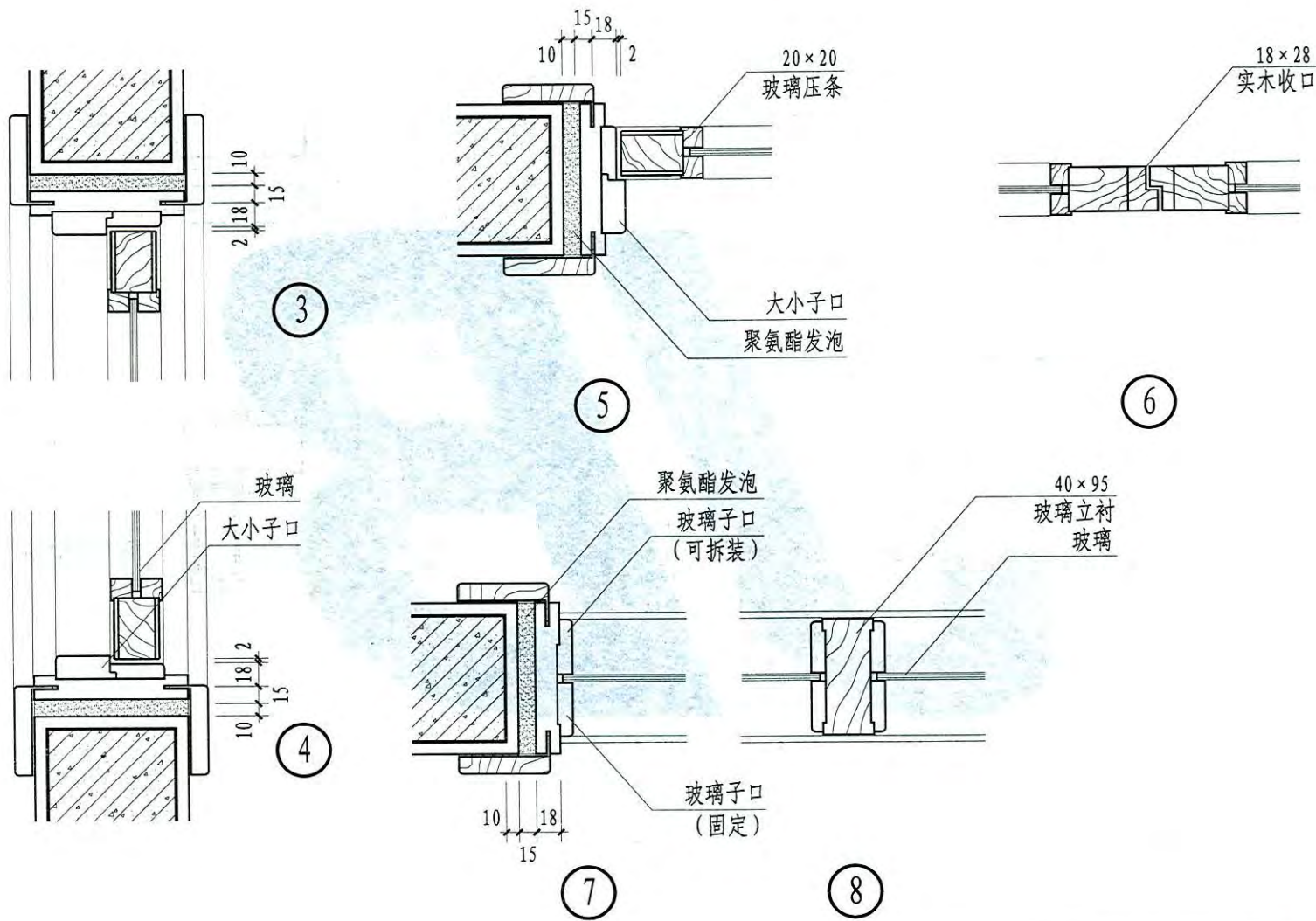

F型-室内平开窗节点图(二)

图集号

12YJ4-1

页次

110

张晚洁  
核  
刘鹰岚  
审  
侯红霞  
对  
侯红霞  
校  
侯红霞  
计  
侯红霞  
设  
侯红霞  
图  
制

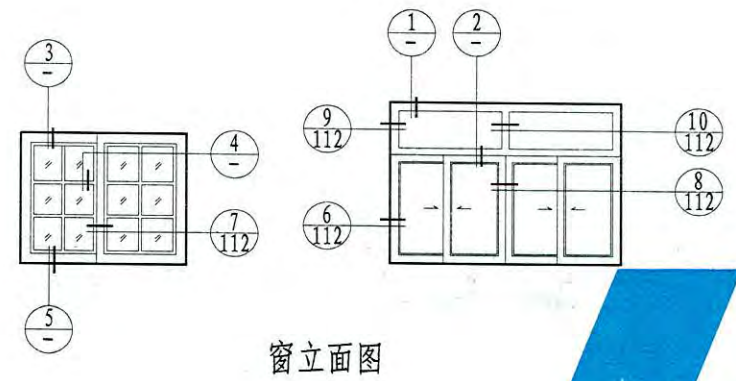

窗立面图

推拉窗五金材料表

数 量	洞口 编号	1206		1506		1806		2406		2706	
		名称	规格	名称	规格	名称	规格	名称	规格	名称	规格
		下滑轮		4		8					
		下滑轨		2		2					
		窗套专用紧固件		8		8					

玻璃子口  
(可拆装)

聚氨酯发泡  
玻璃子口  
(固定)  
玻璃

40×100  
上亮横档  
15×6  
实木嵌条  
62×28  
上梃

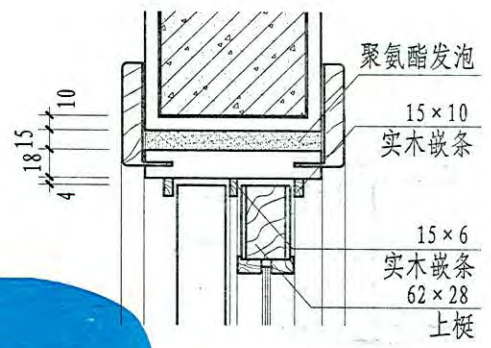

3

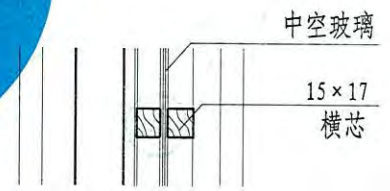

4

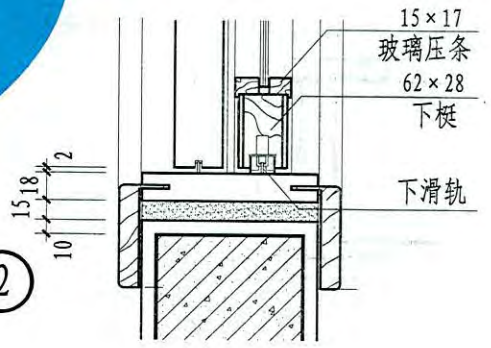

5

F型-推拉窗节点图 (一)

图集号	12YJ4-1
页次	111

张 晓 洁  
核 审  
刘 鹰 岚  
对 校  
侯 红 霞  
计 设  
侯 红 霞  
图 制

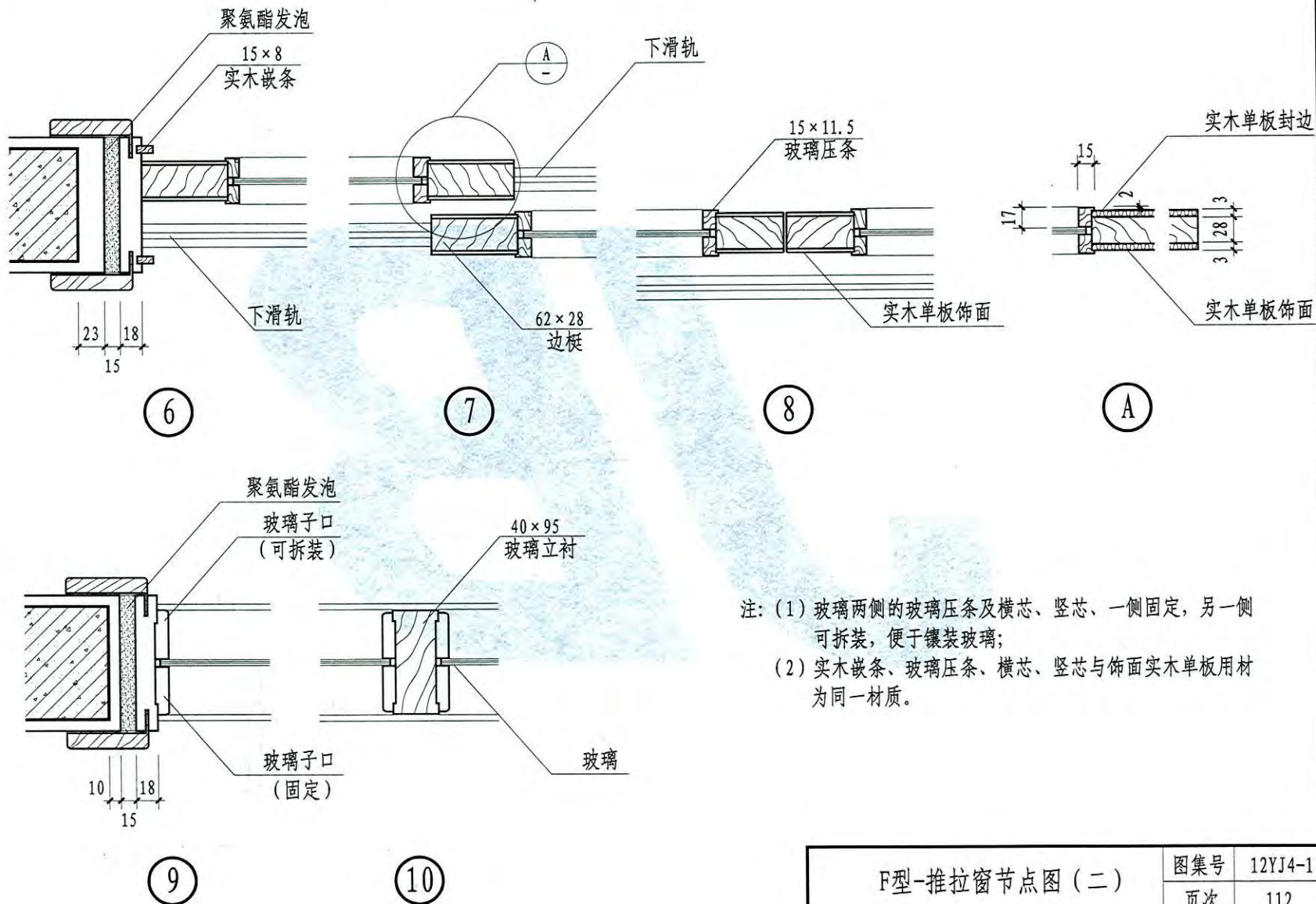

F型-推拉窗节点图(二)

图集号	12YJ4-1
页次	112

张 晓 洁  
核 审  
刘 鹰 岚  
对 校  
侯 红 霞  
计 设  
侯 红 霞  
制 图

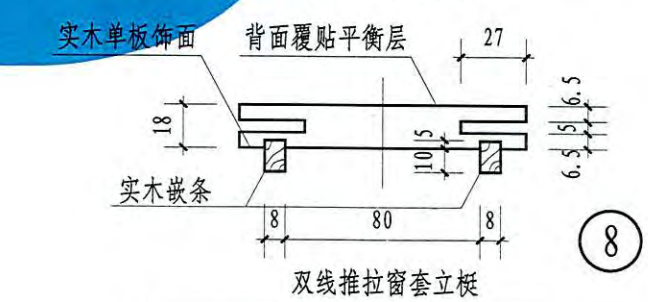
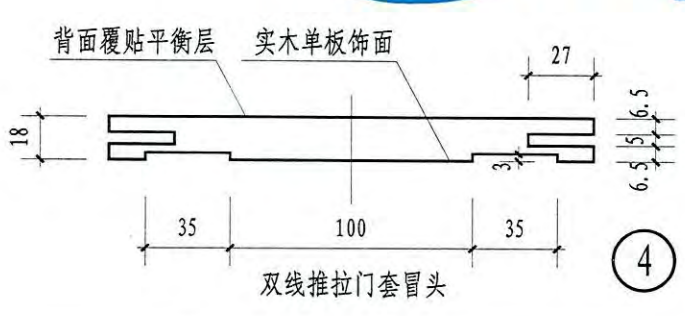
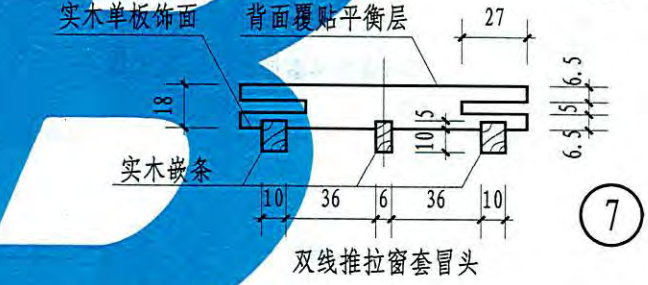
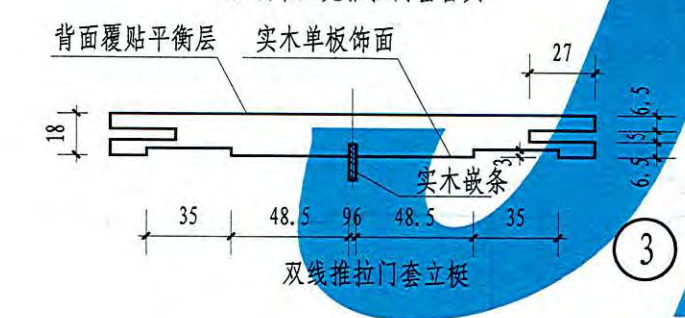
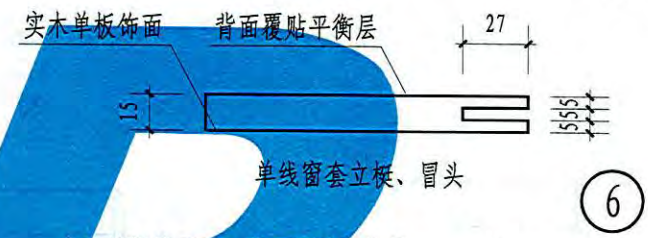
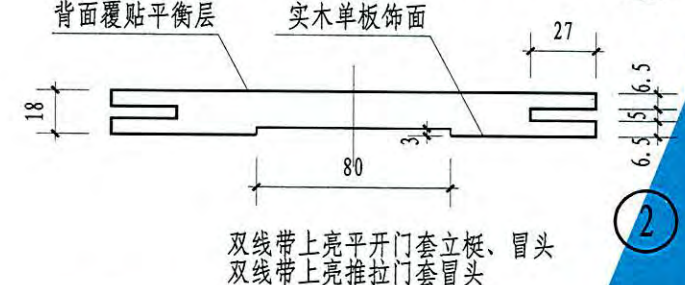
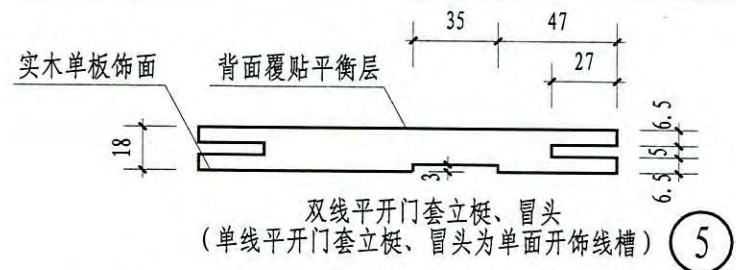
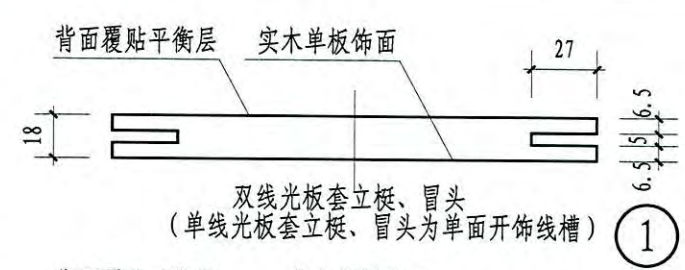

门窗套部件截面图 (一)

图集号	12YJ4-1
页次	113

张晓洁  
核  
审  
刘鹰凤  
对  
校  
侯红霞  
设计  
侯红霞  
制图

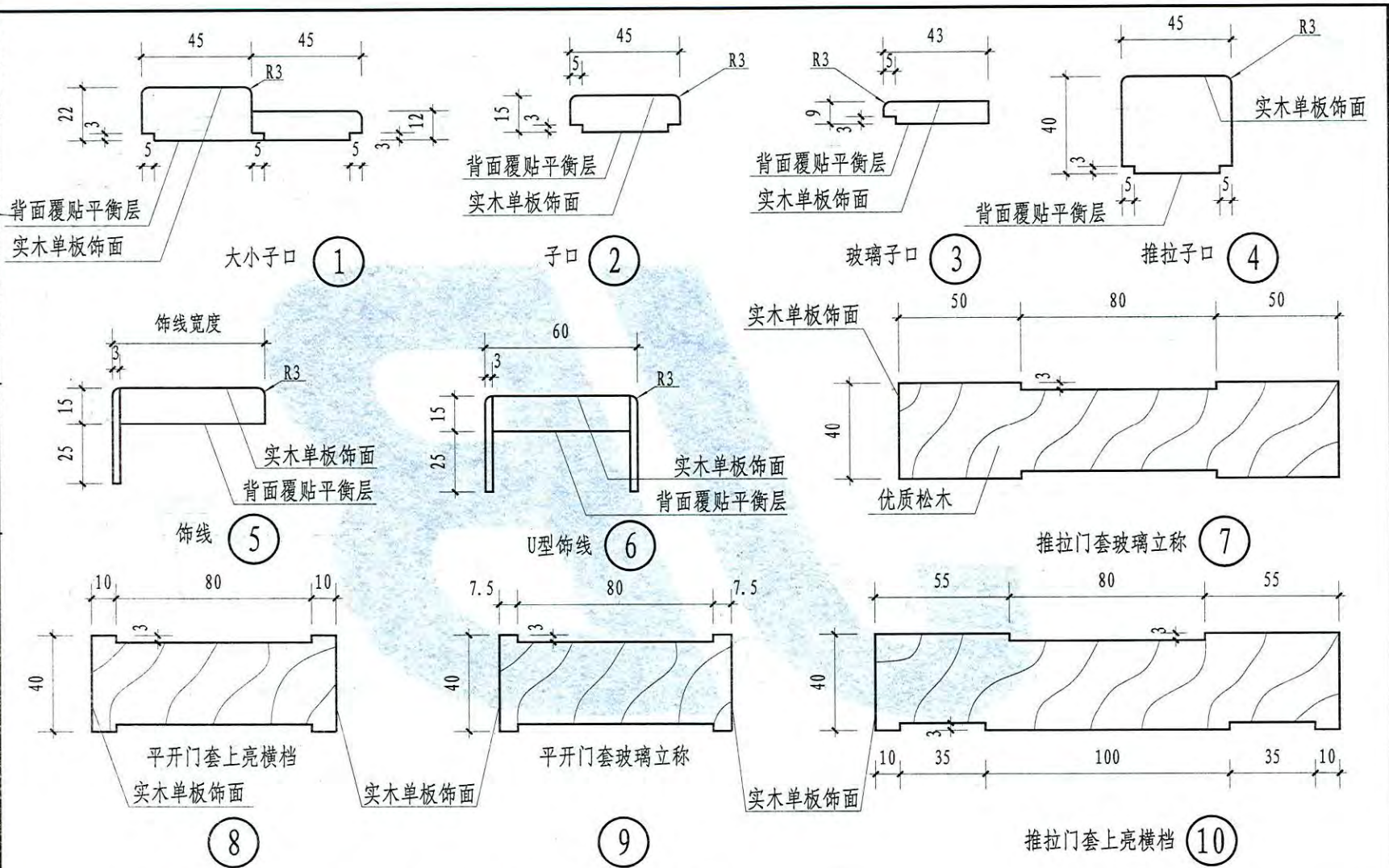

注：(1) 门窗套立梃、冒头、子口、饰线等部件加工时基材采用优质中密度纤维板，饰面材料选用0.6mm优质天然实木单板、背面覆贴防潮平衡层。  
(2) 饰线宽度按设计选定。

门窗套部件截面图(二)

图集号	12YJ4-1
页次	114





张婉洁	加
刘鹰	研
侯红霞	原
侯红霞	原

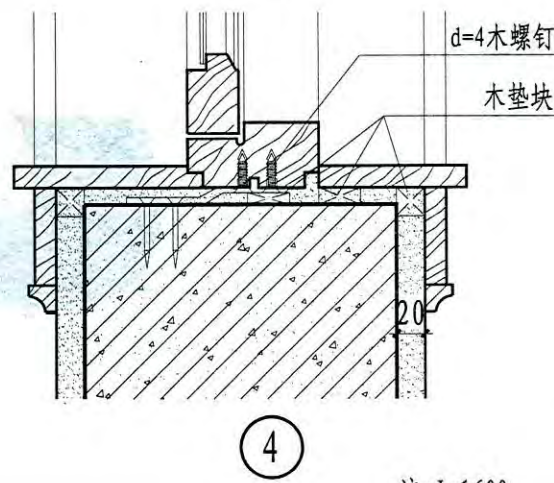
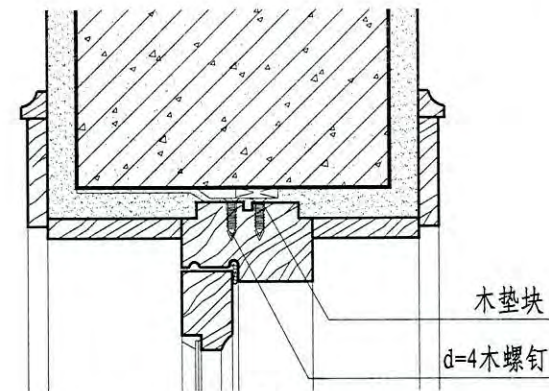
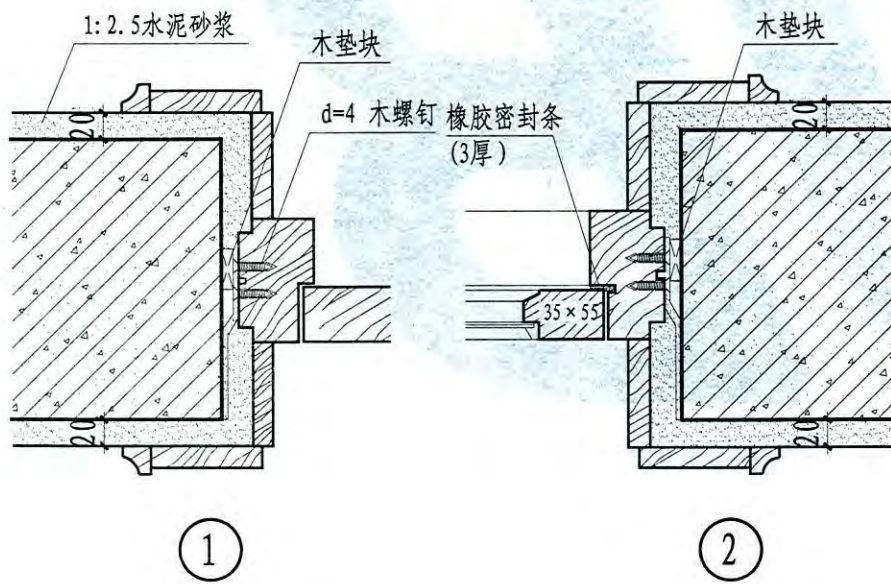
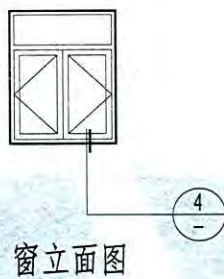
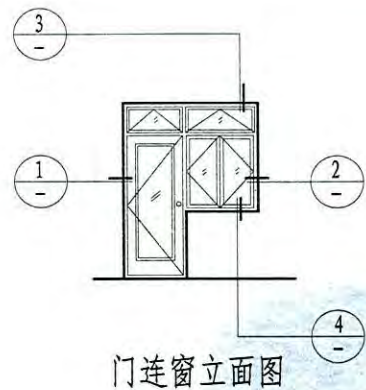

注: L ≤ 600

平开门连窗安装节点图

图集号	12YJ4-1
页次	116